

版面图

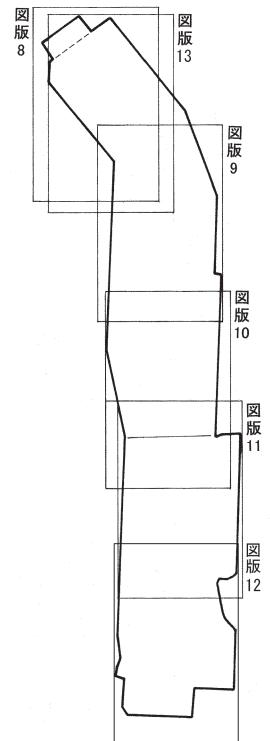

図面図版1 宇治市街遺跡の位置

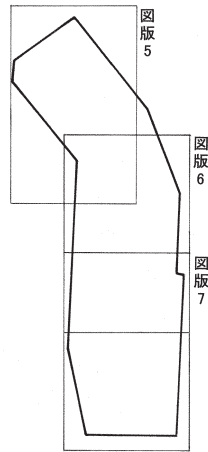

図面図版2 宇治市街遺跡の範囲と調査地の位置図



図面図版3 調査地周辺地形図①



図面図版 4 調査地周辺地形図②



図面図版5 トレンチ平面実測図



Y=-17735

Y=-17725

X=-123.430

X=-123.430

X=-123.440

X=-123.440

X=-123.450

X=-123.450

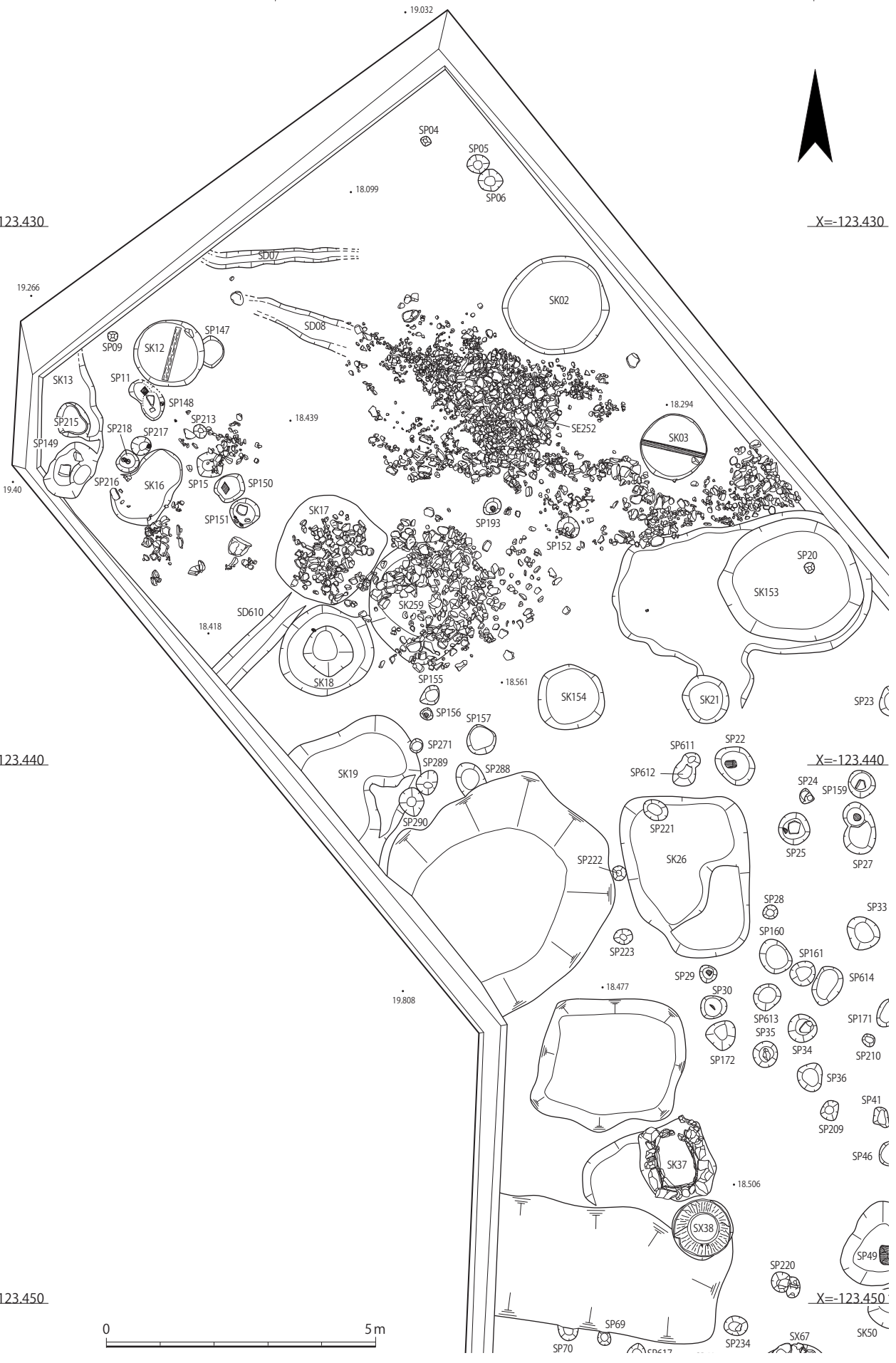

図面図版 8
トレンチ平面実測図

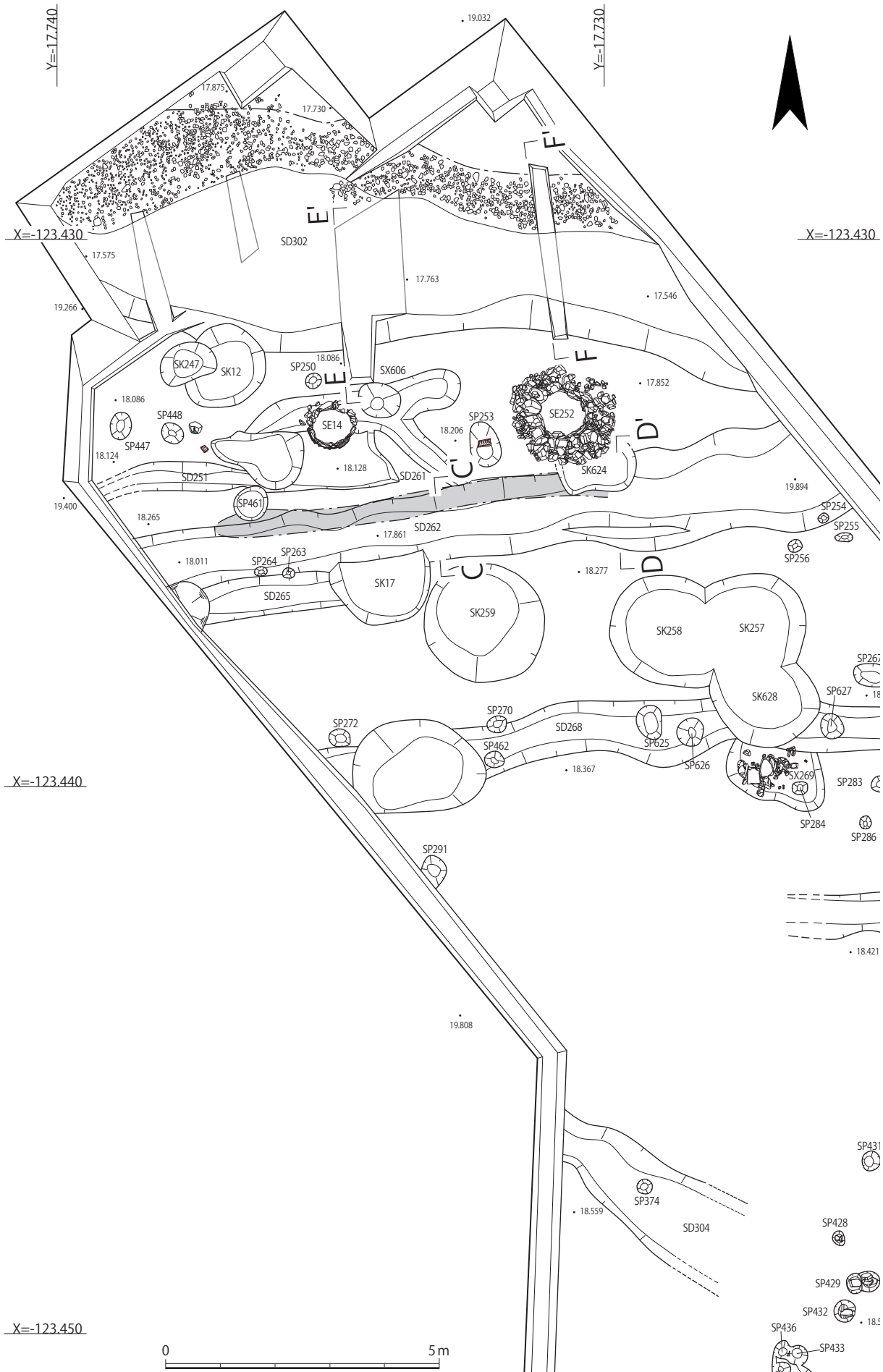

図面図版 9 トレンチ平面実測図

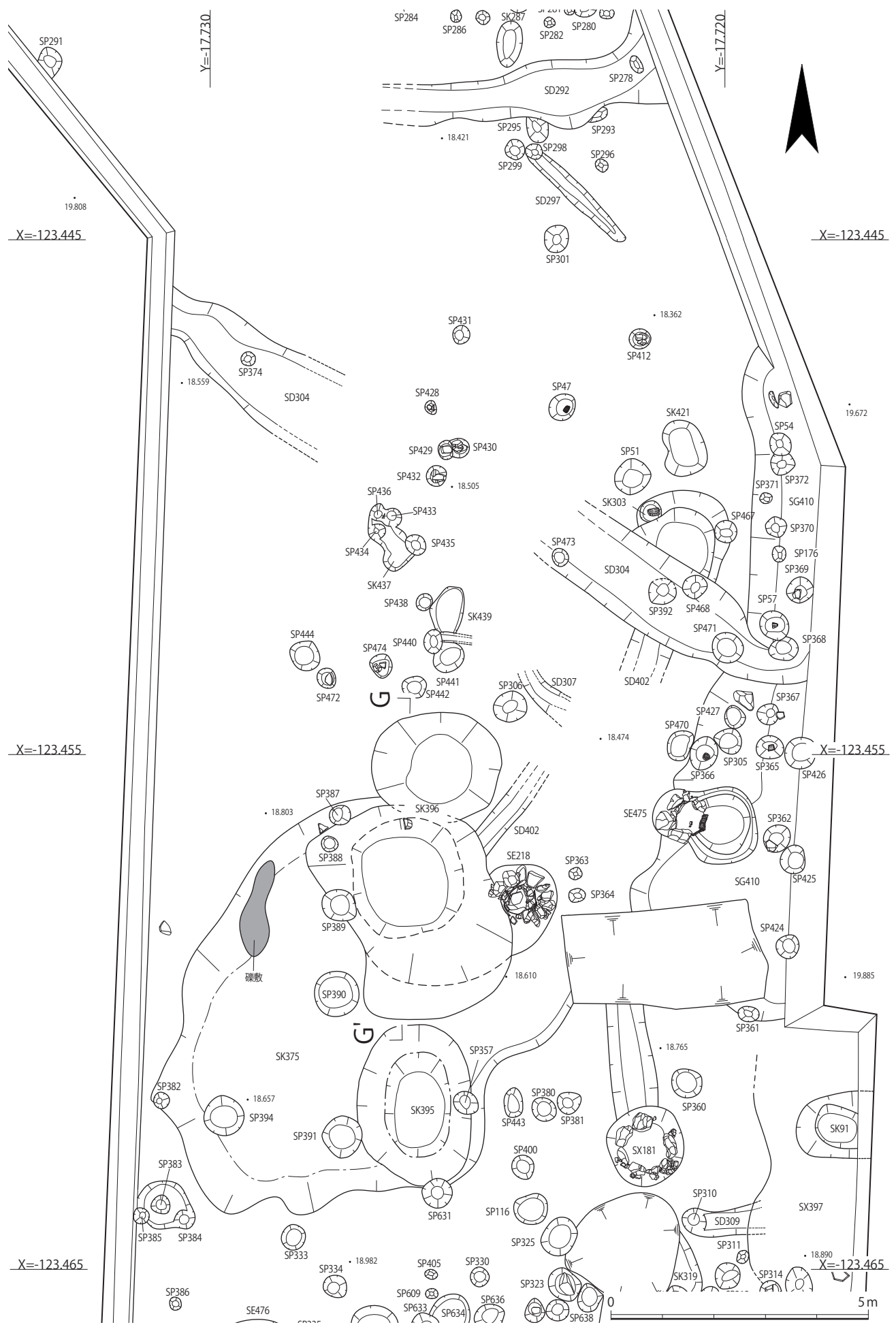

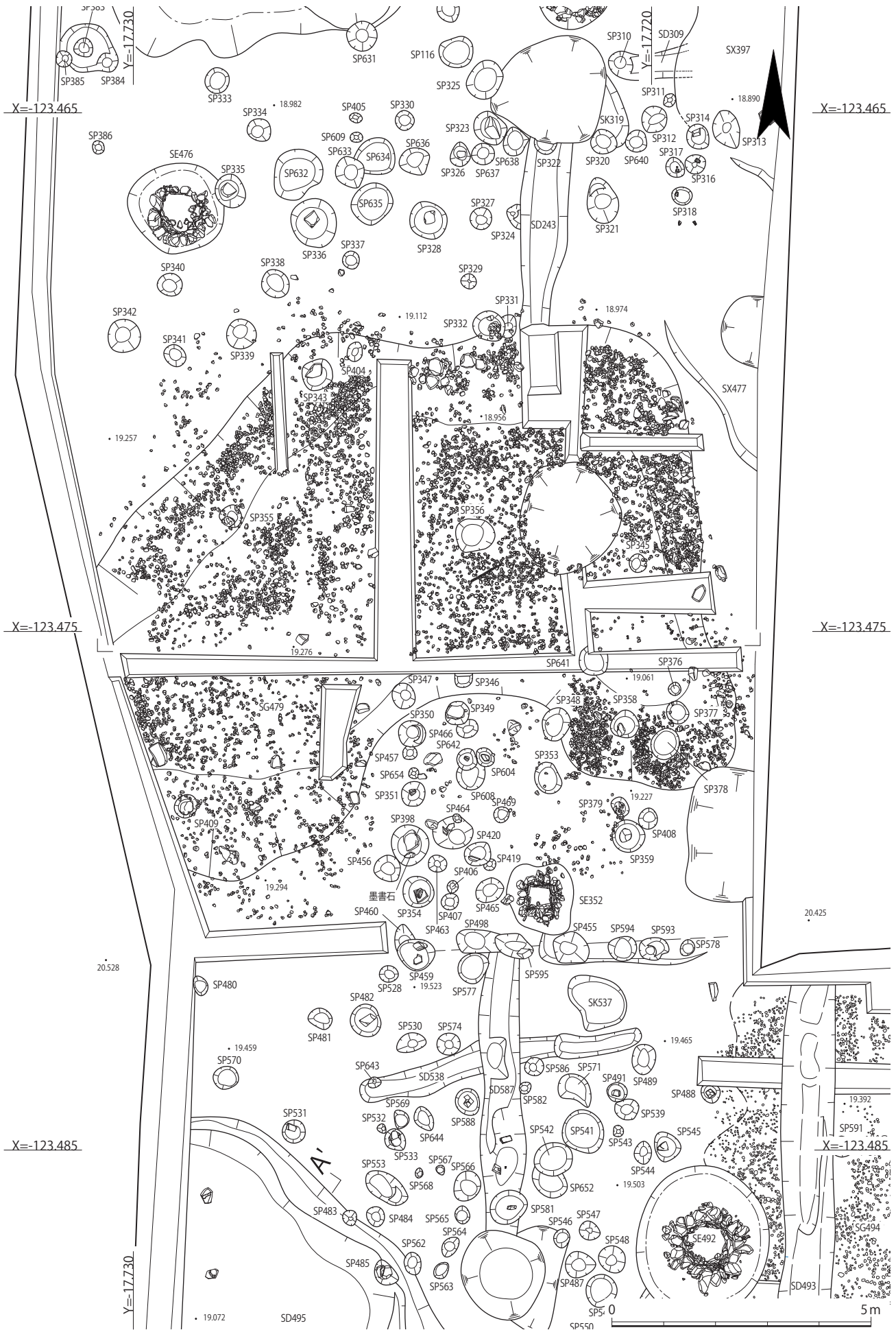

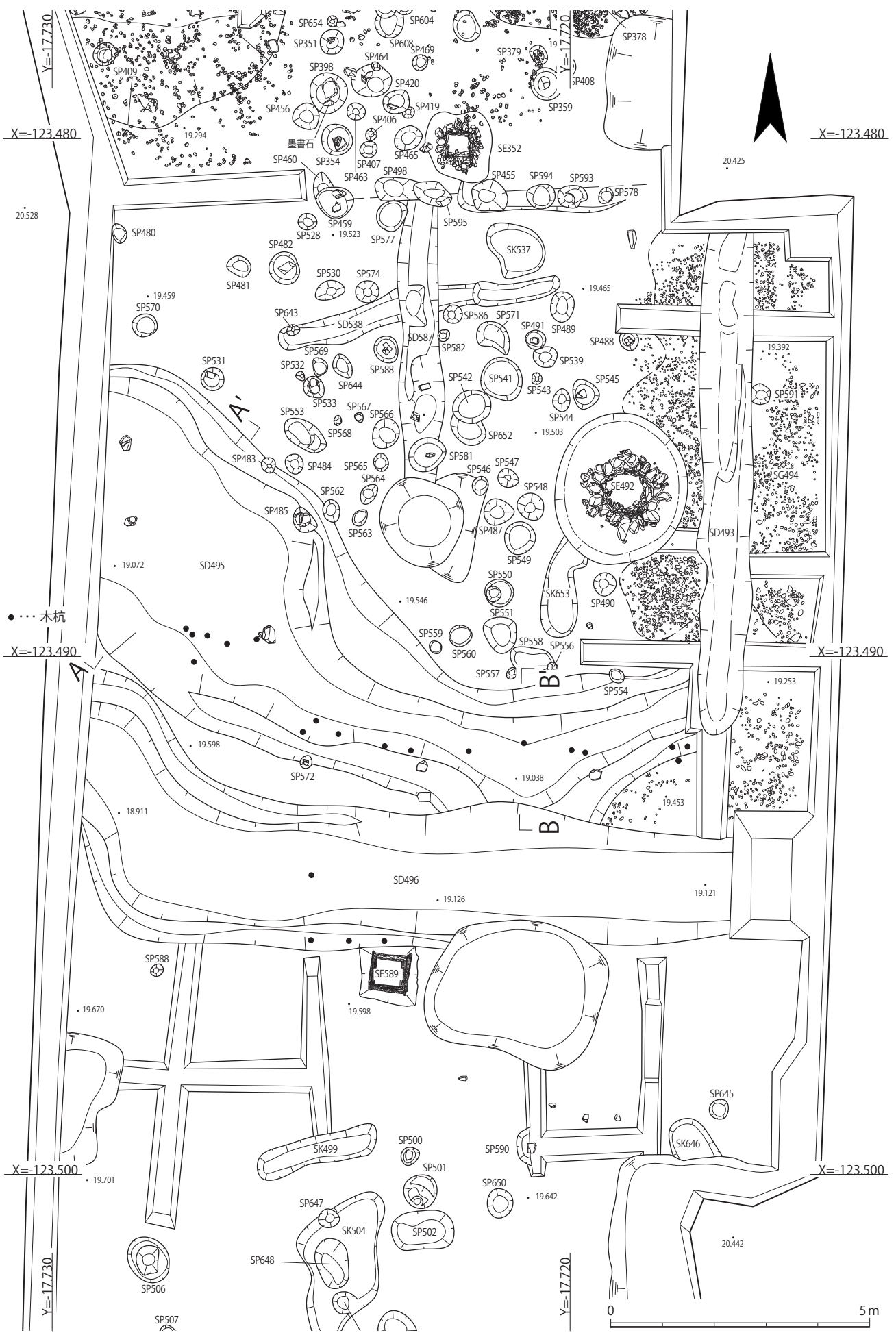

図面図版 12
トレンチ平面実測図

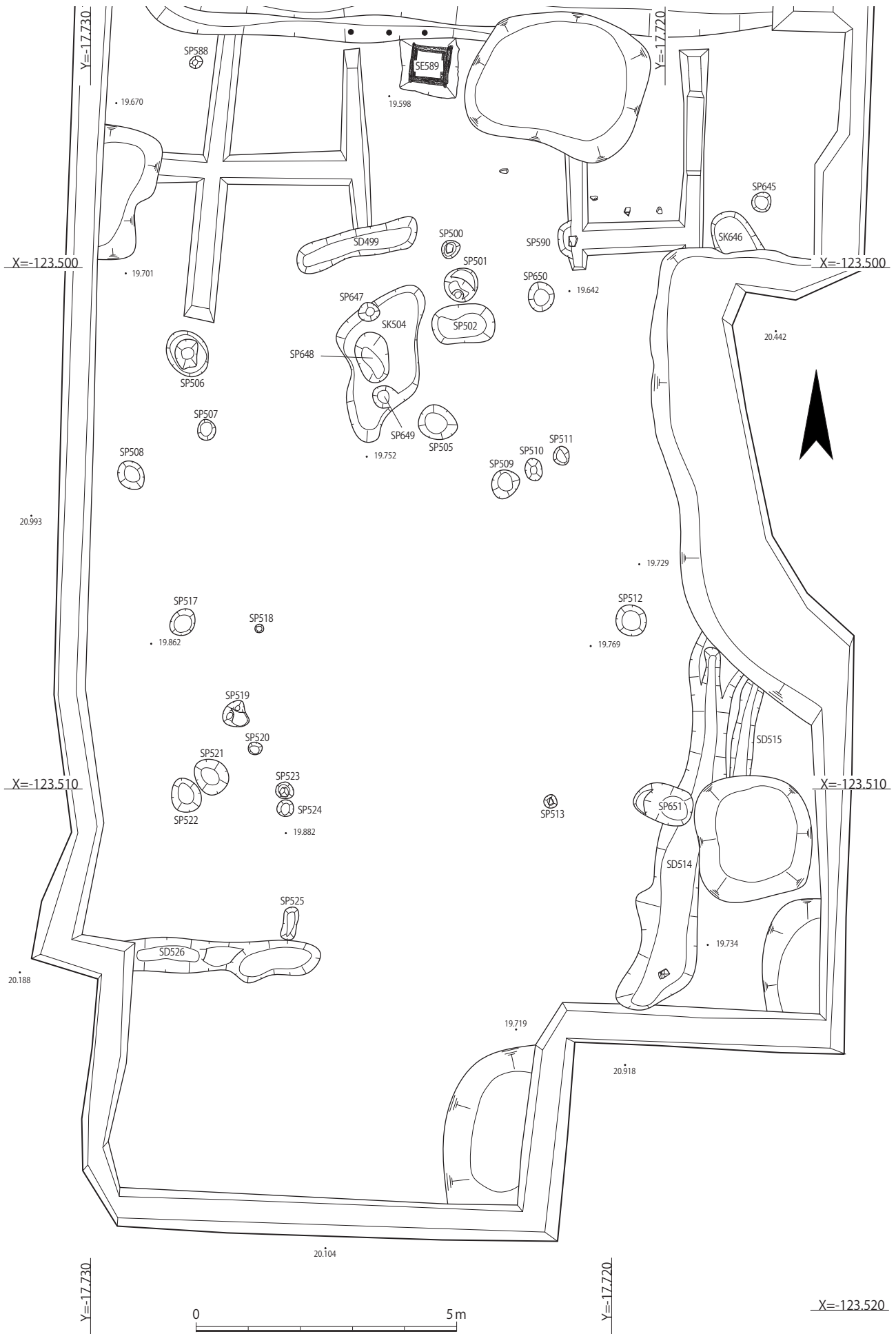

SD493

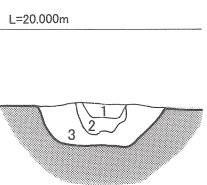
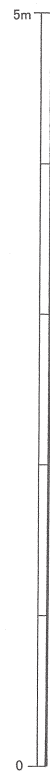
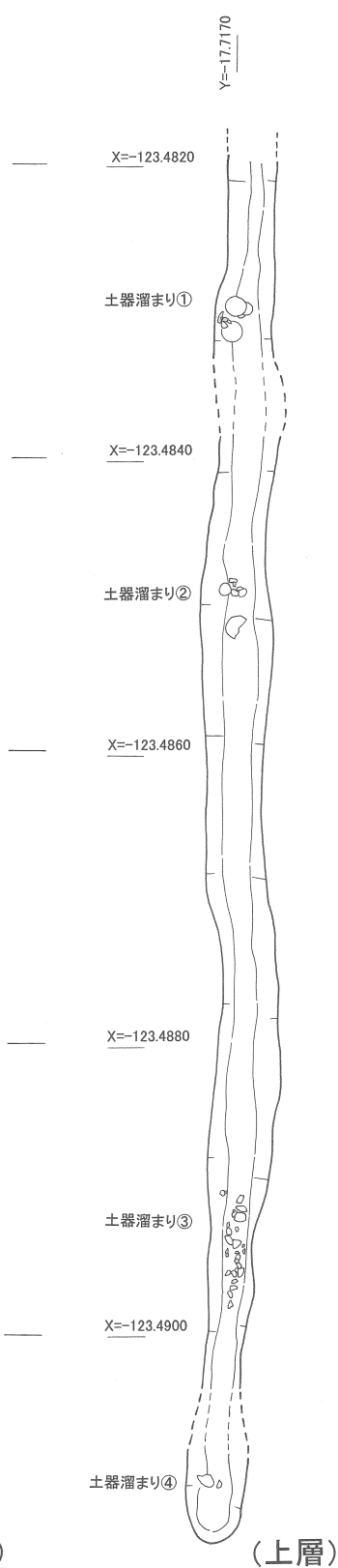
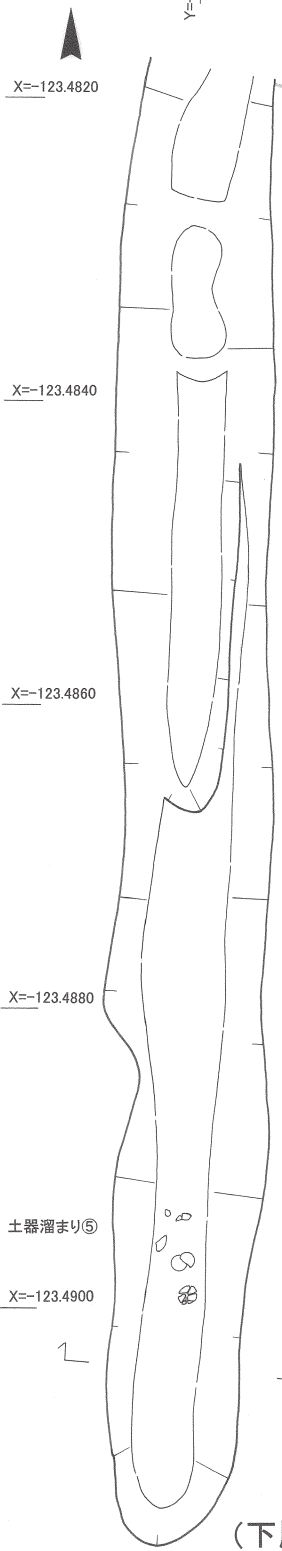

SD493
 1: 暗褐色粘質土(上層)
 2: 黒褐色粘質土(上層)
 3: にぶい黄褐色砂質土(下層)

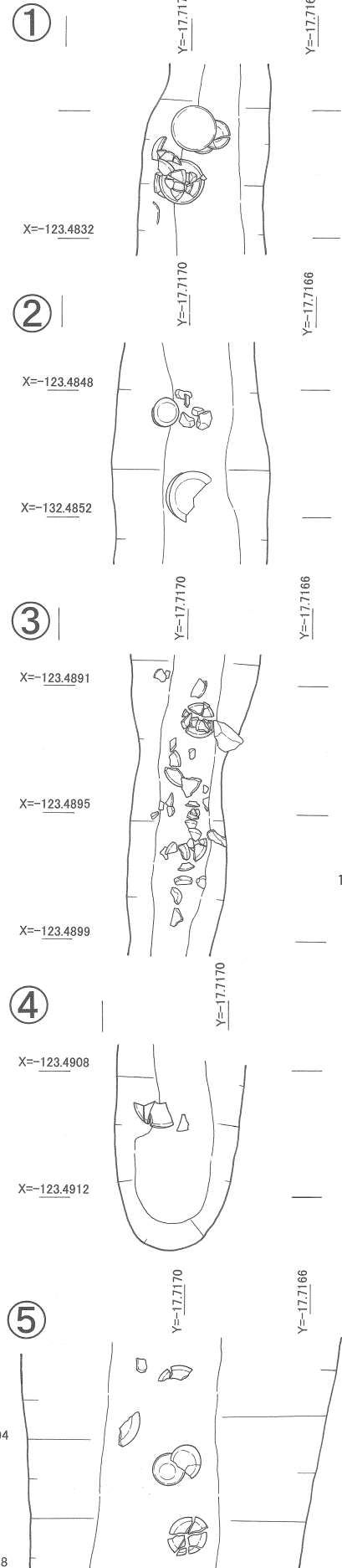

SE01

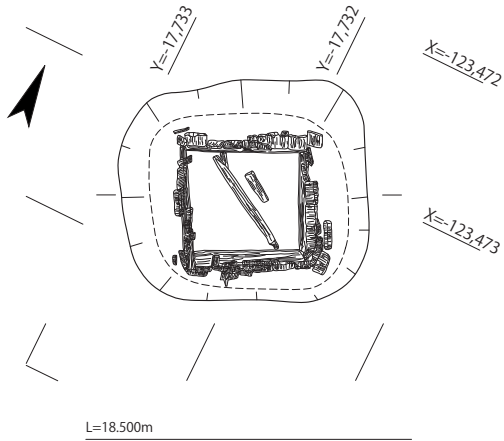

L=18.500m



SE218

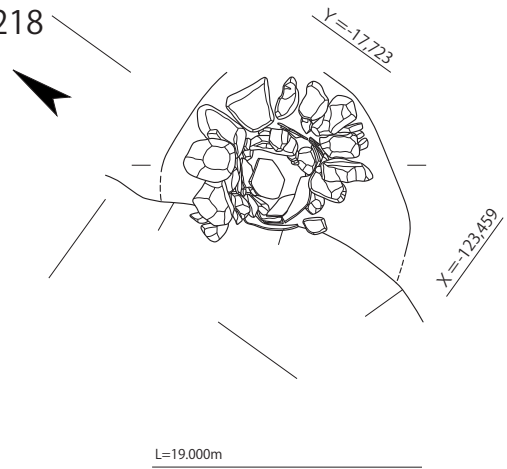

L=19.000m



SE475

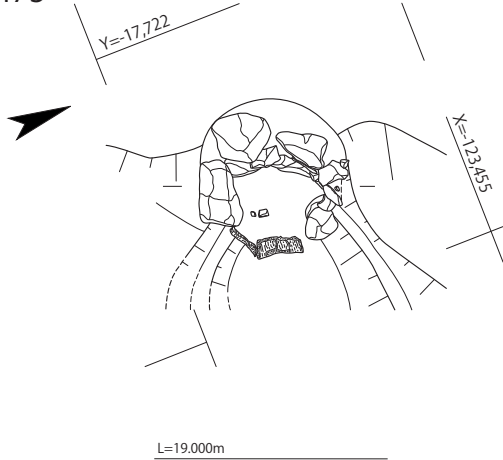

L=19.000m

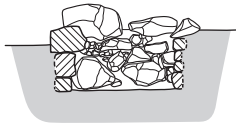

SE476

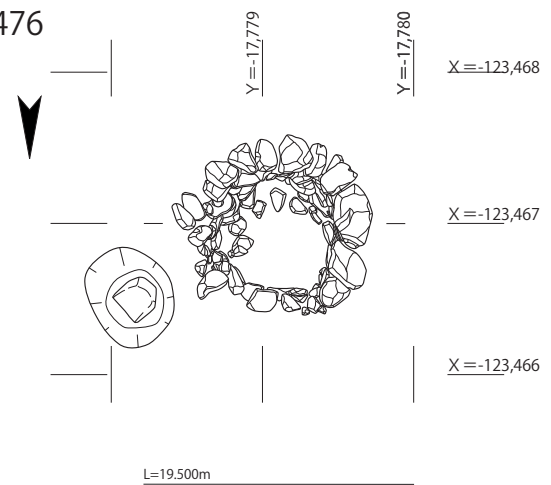

L=19.500m



SE589

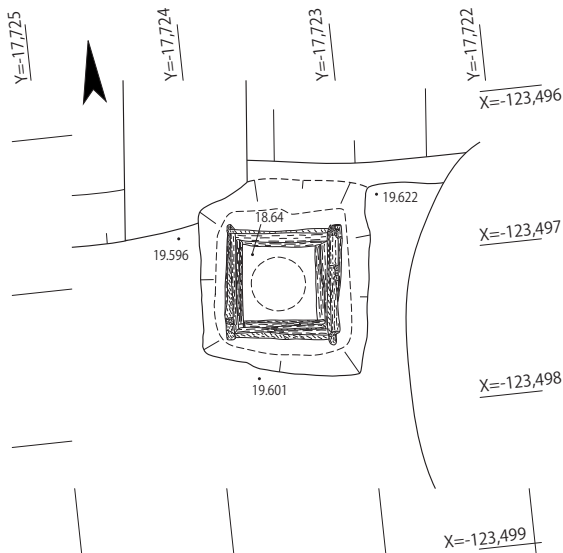

SX181

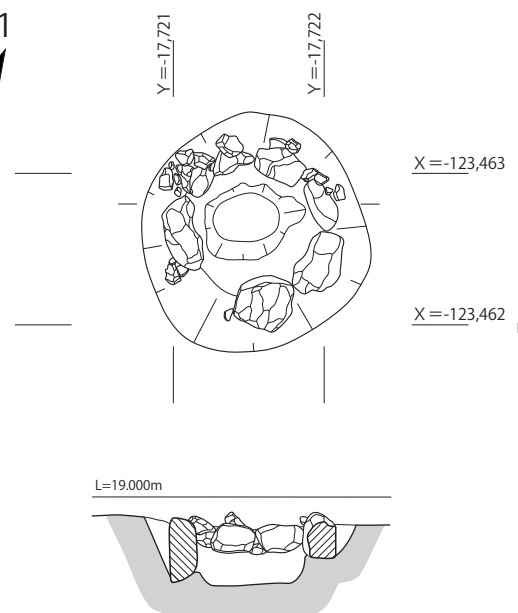

L=19.000m

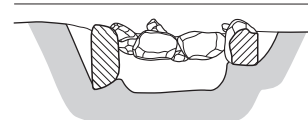

SD495

L=20,000m

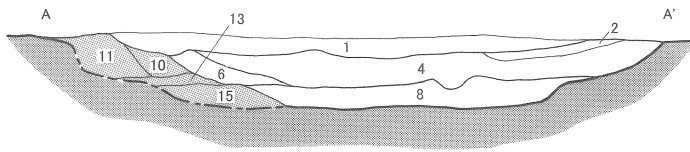

L=20,000m

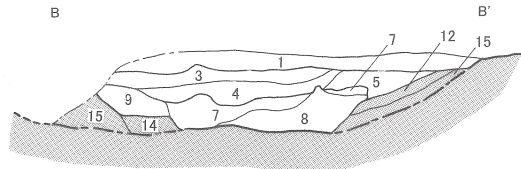

- | | |
|----------------------|--------------------|
| 1: 黒褐色土 (上層) | 9: 黒褐色混礫土 (下層) |
| 2: 黄灰色砂質土 (中層) | 10: にぶい黄褐色砂質土 [地山] |
| 3: 黒褐色土 (礫含む; 中層) | 11: 灰オリーブ砂質土 [地山] |
| 4: 暗黒褐色土 (中層) | 12: 暗灰黄色砂質土 [地山] |
| 5: 黒褐色土 (礫多く含む; 中層) | 13: 黒褐色砂質土 [地山] |
| 6: 黒褐色混礫土 (下層) | 14: 灰オリーブ砂質土 [地山] |
| 7: 黒色土 (植物遺体等含む; 下層) | 15: 暗オリーブ砂質土 [地山] |
| 8: 灰オリーブ砂質土 (下層) | |

SD262

L=18,500m

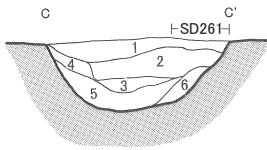

L=18,500m

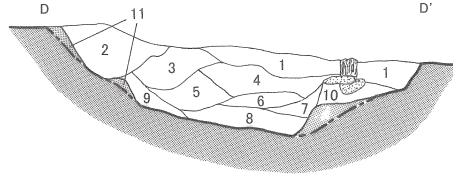

- 1: 黒褐色粘質土
- 2: 褐灰色砂
- 3: 褐色砂
- 4: 黄灰色砂 (礫含む)
- 5: オリーブ黒色粘質土 (礫含む)
- 6: 灰色砂

- | | |
|-------------------|-------------------|
| 1: 黒褐色粘質土 | 7: 黒褐色砂 (植物遺体等含む) |
| 2: 灰黄色砂 (礫含む) | 8: 暗褐色粘質土 |
| 3: 褐灰色砂 (植物遺体等含む) | 9: 暗オリーブ褐色粘質土 |
| 4: 黒色粘質土 (礫含む) | 10: オリーブ黒色砂 (礫含む) |
| 5: 黒褐色砂 (植物遺体等含む) | 11: 暗灰黄色砂 [地山] |
| 6: 黄灰色砂 | 12: 黄灰色砂 [地山] |

SD302

L=18,500m

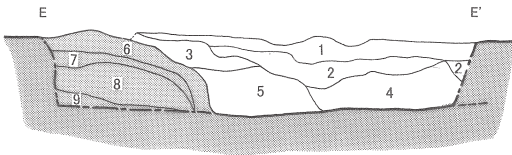

L=18,500m

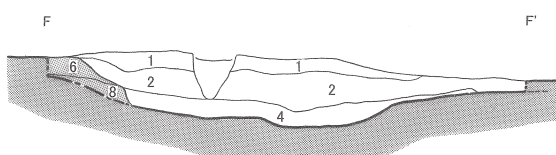

- | | |
|----------------------------|-------------------|
| 1: 黒色粘質土 (土器・礫含む; 上層) | 6: 灰黄褐色砂 [地山] |
| 2: 黒褐色粘質土 (土器・植物遺体等含む; 中層) | 7: オリーブ灰色粘質土 [地山] |
| 3: 黒褐色砂質土 (土器等含む; 中層) | 8: 灰黄褐色シルト [地山] |
| 4: 黄褐色砂質土 (土器・木製品類等含む; 下層) | 9: 黒色シルト [地山] |
| 5: 黄灰色粘質土 (木製品類等含む; 下層) | |

SK396

L=19,000m

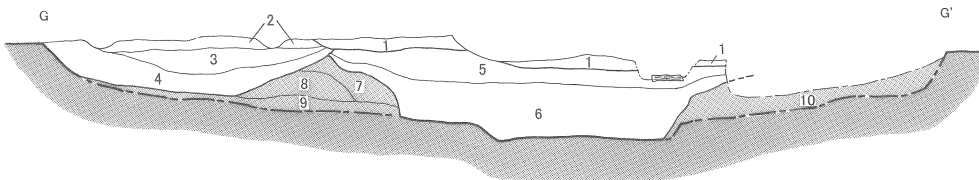

- 1: 暗褐色砂質土
- 2: にぶい黄褐色砂質土
- 3: 褐灰色砂質土 (礫含む)
- 4: 黒色粘質土 (土器・木製品類・植物遺体多く含む)
- 5: 黒褐色砂礫土
- 6: オリーブ褐色粘質土
- 7: オリーブ褐色砂質土 [地山]
- 8: 黄褐色砂質土 [地山]
- 9: 黒褐色粘質土 [地山]
- 10: 明黄褐色砂礫土 [地山]



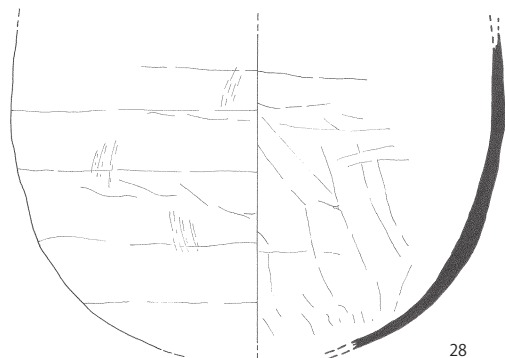
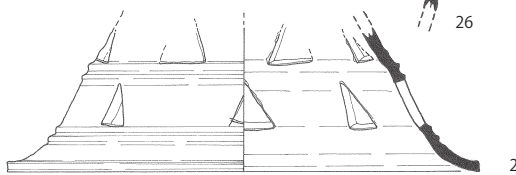
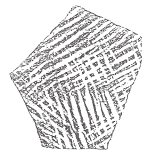
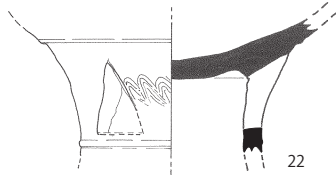
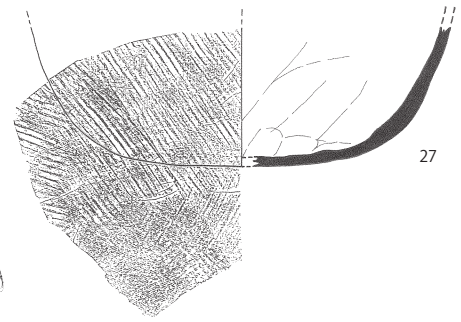
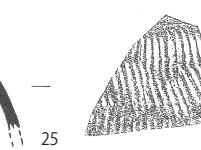
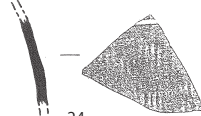
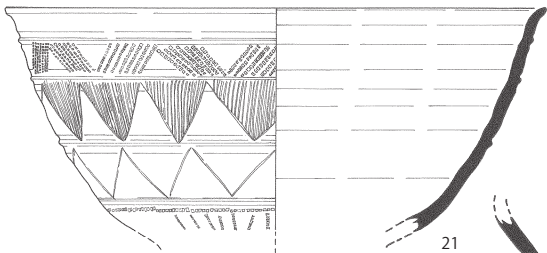
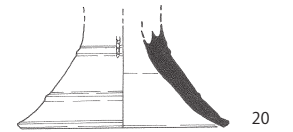
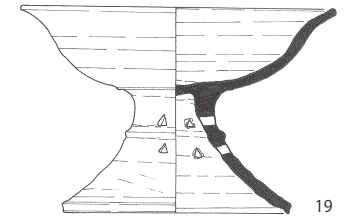
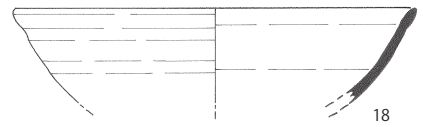
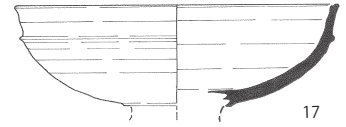
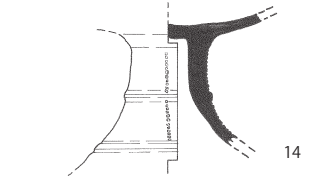
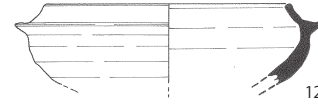
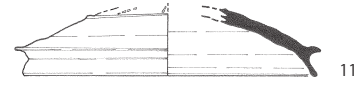
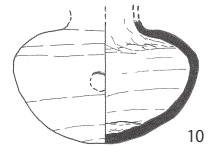
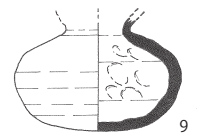
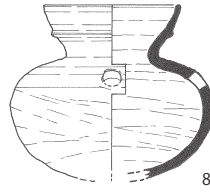
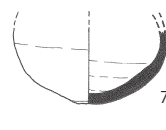
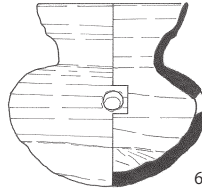
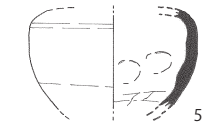
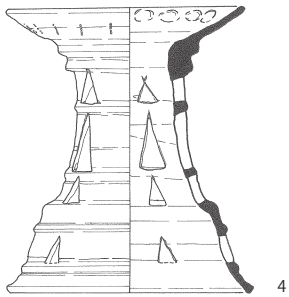
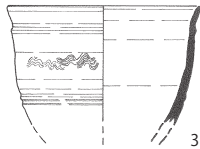
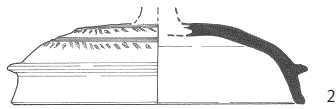
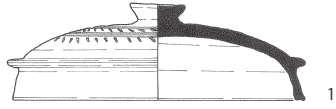
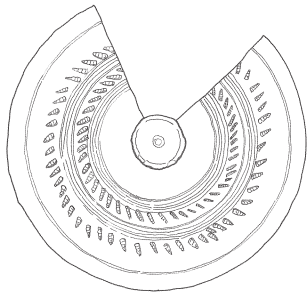

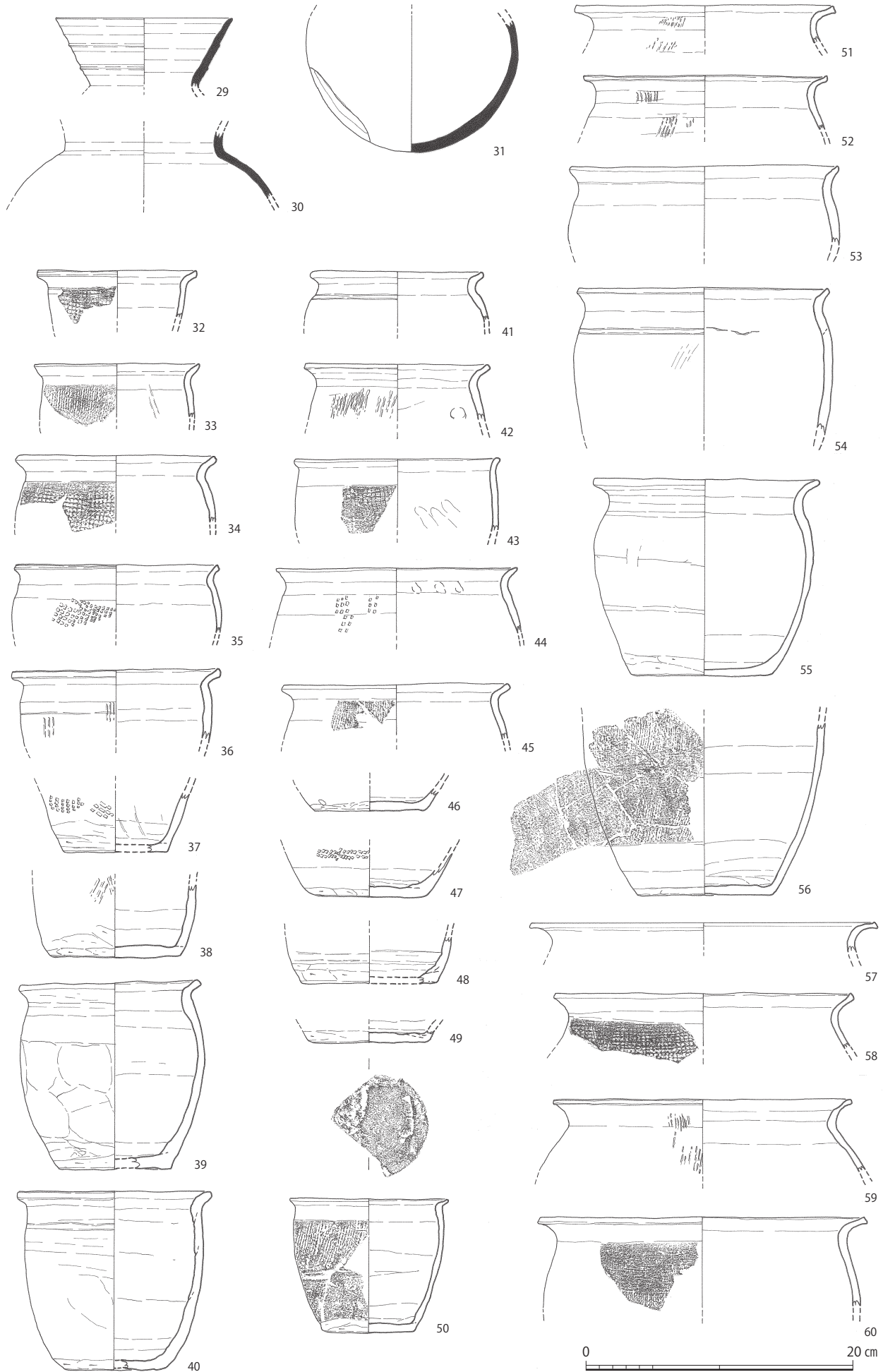

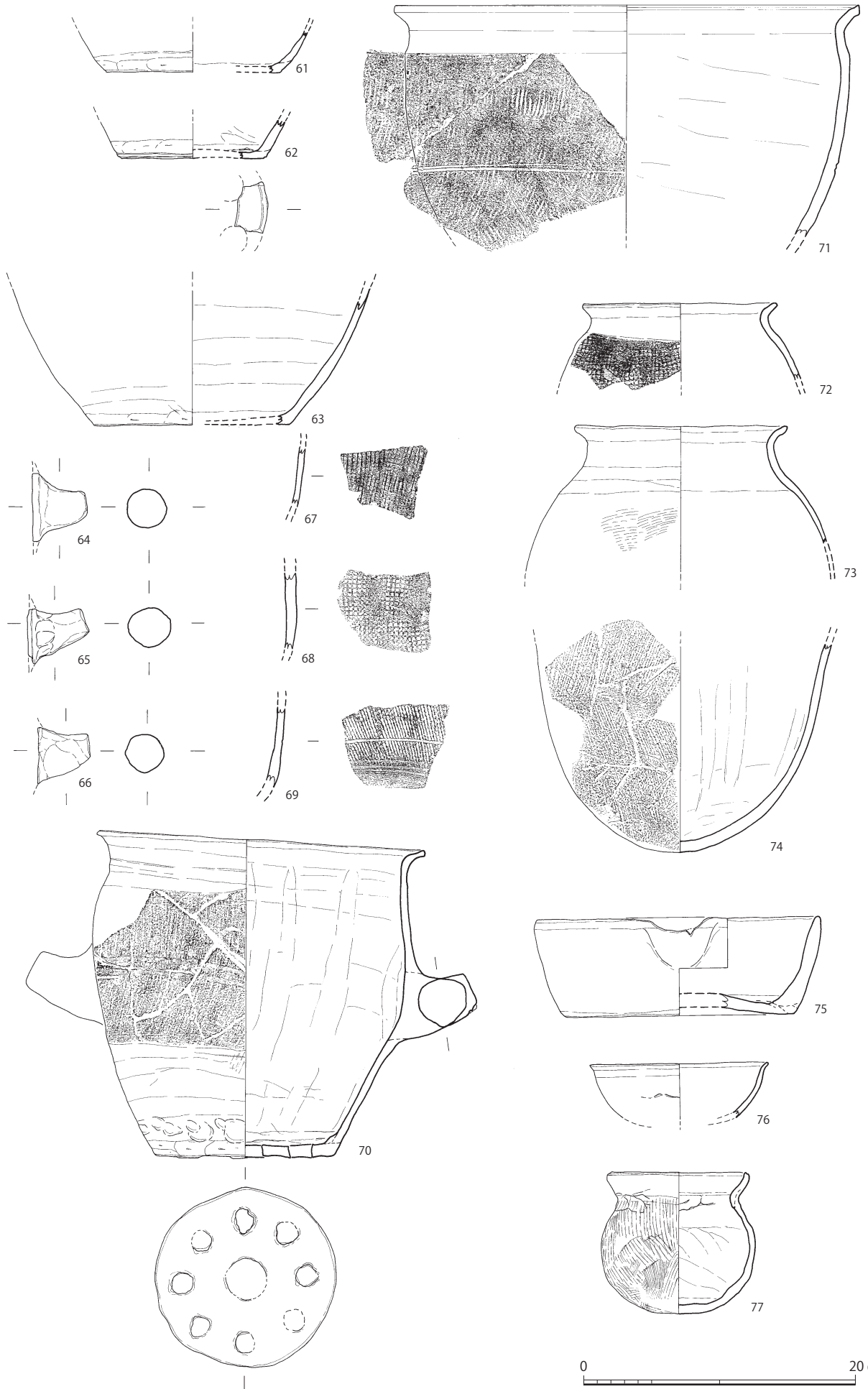

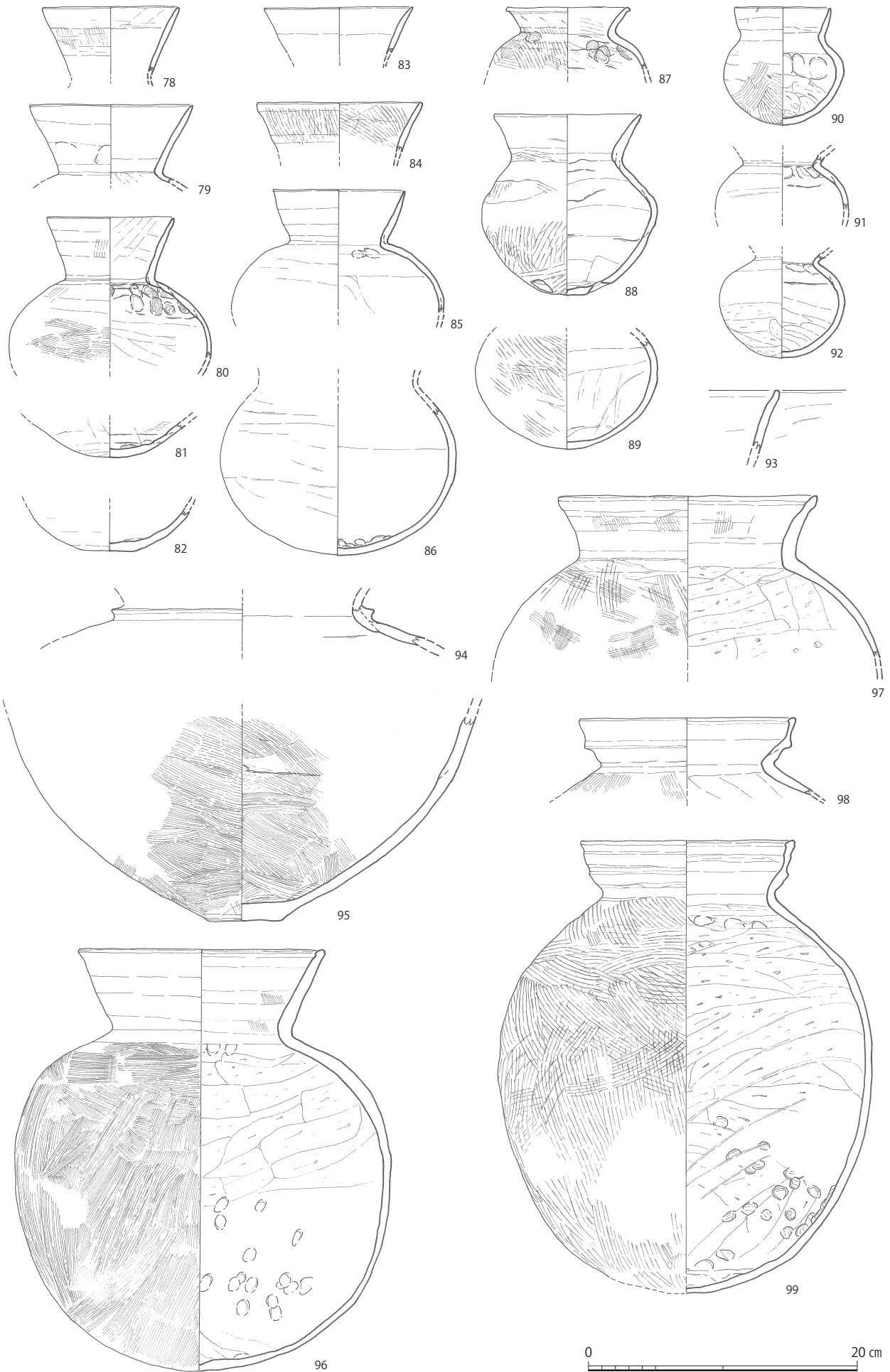

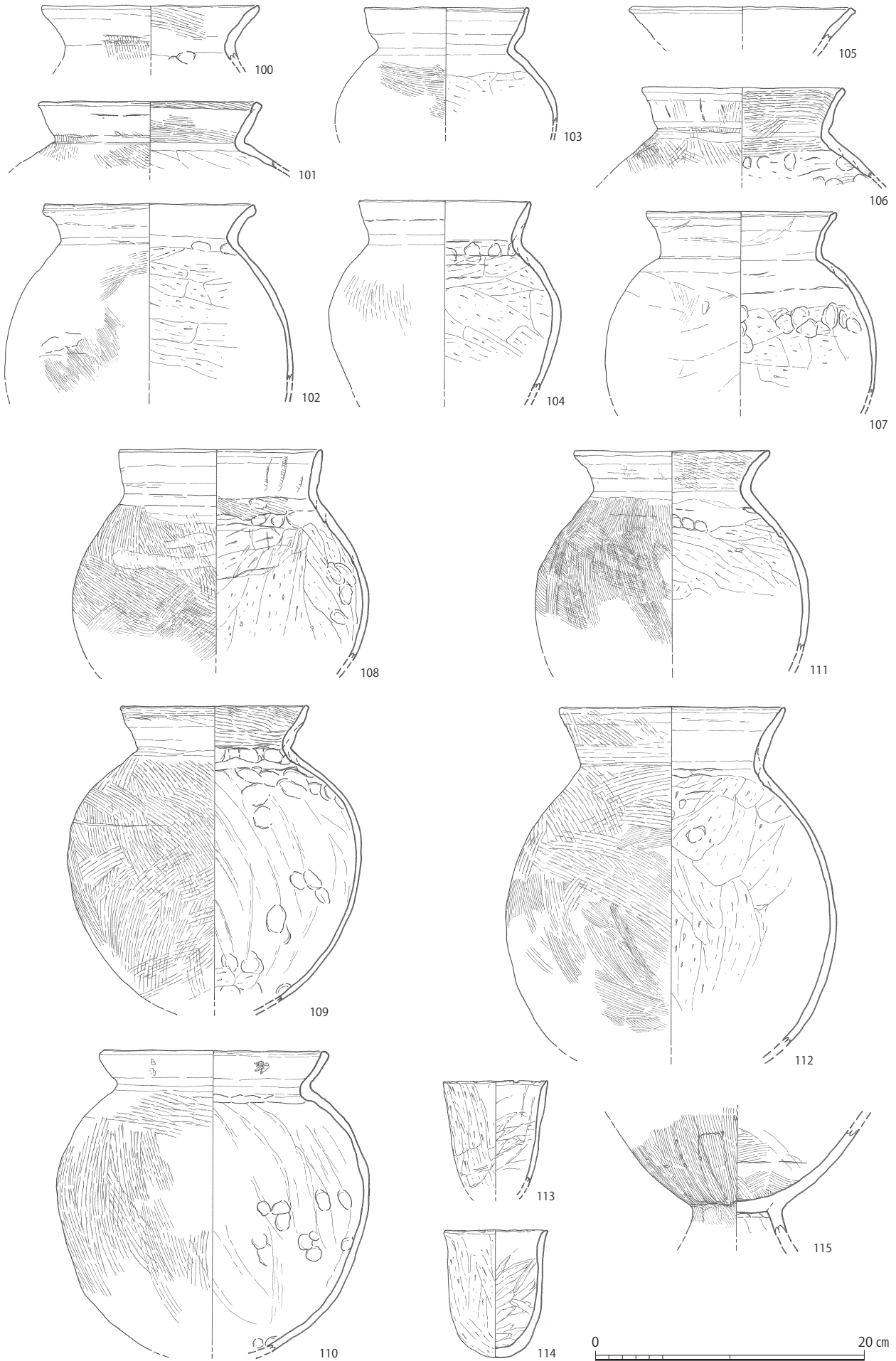

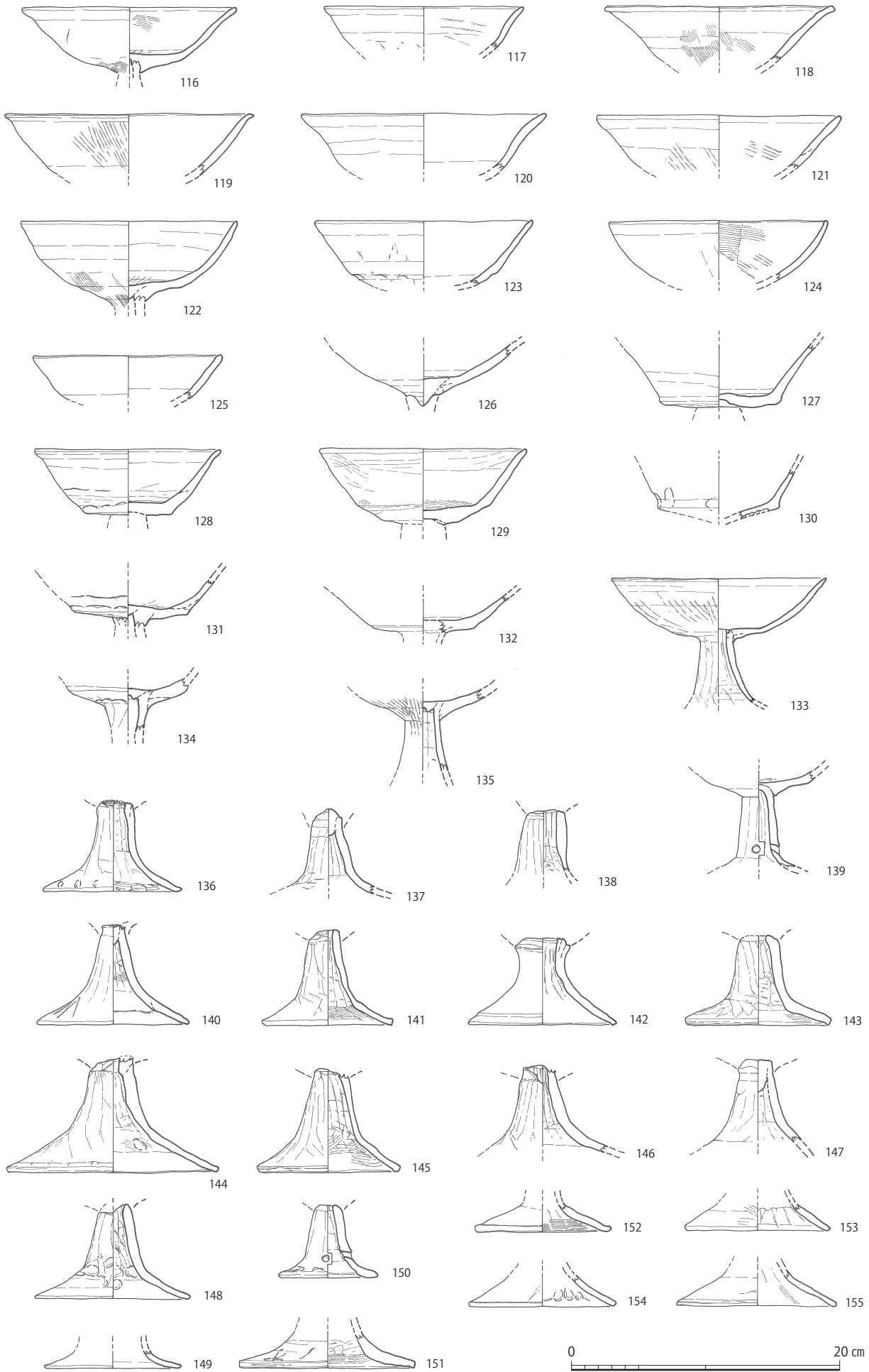

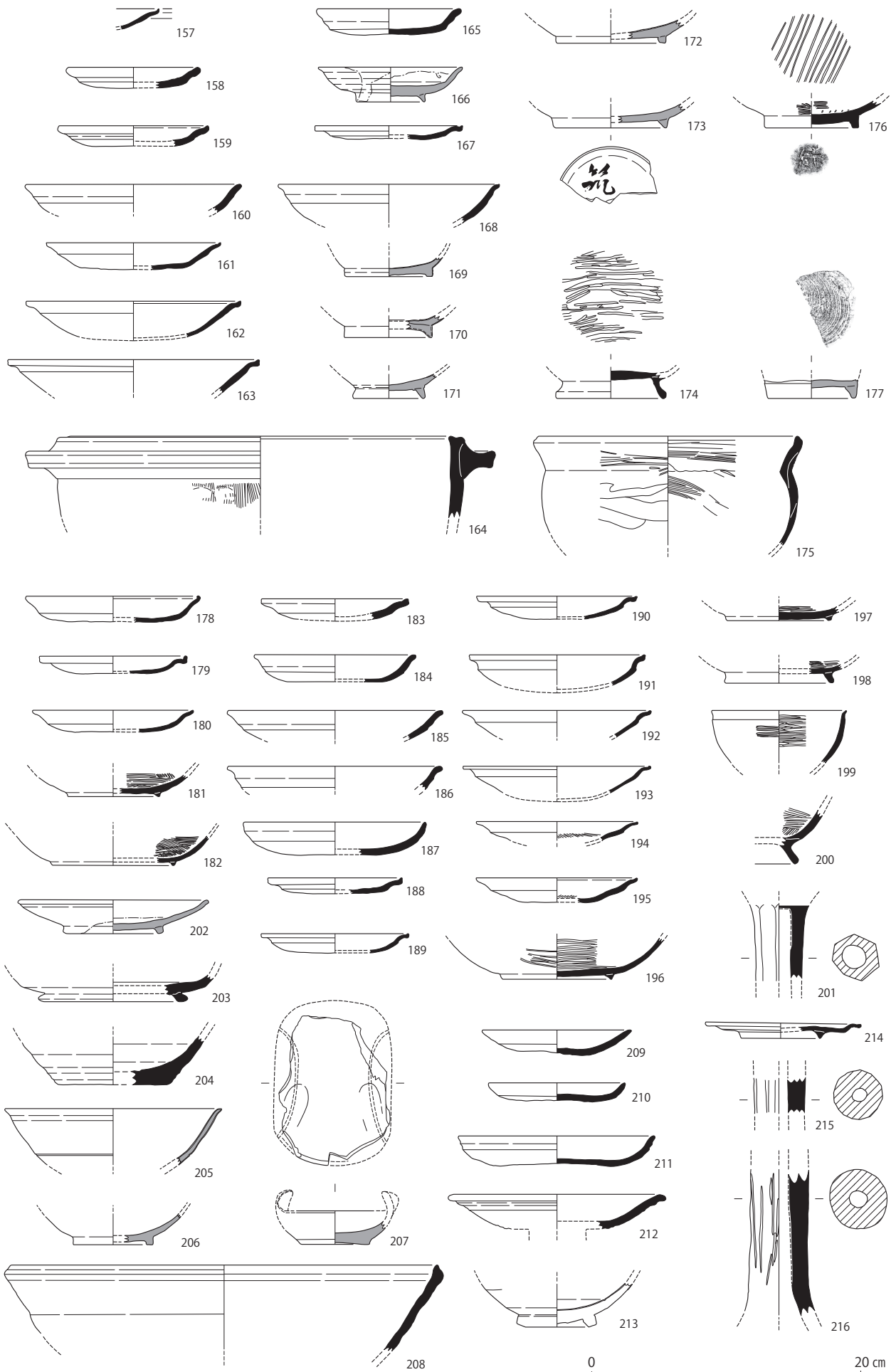

SD495 : 157 ~ 177、SG479 : 178 ~ 216

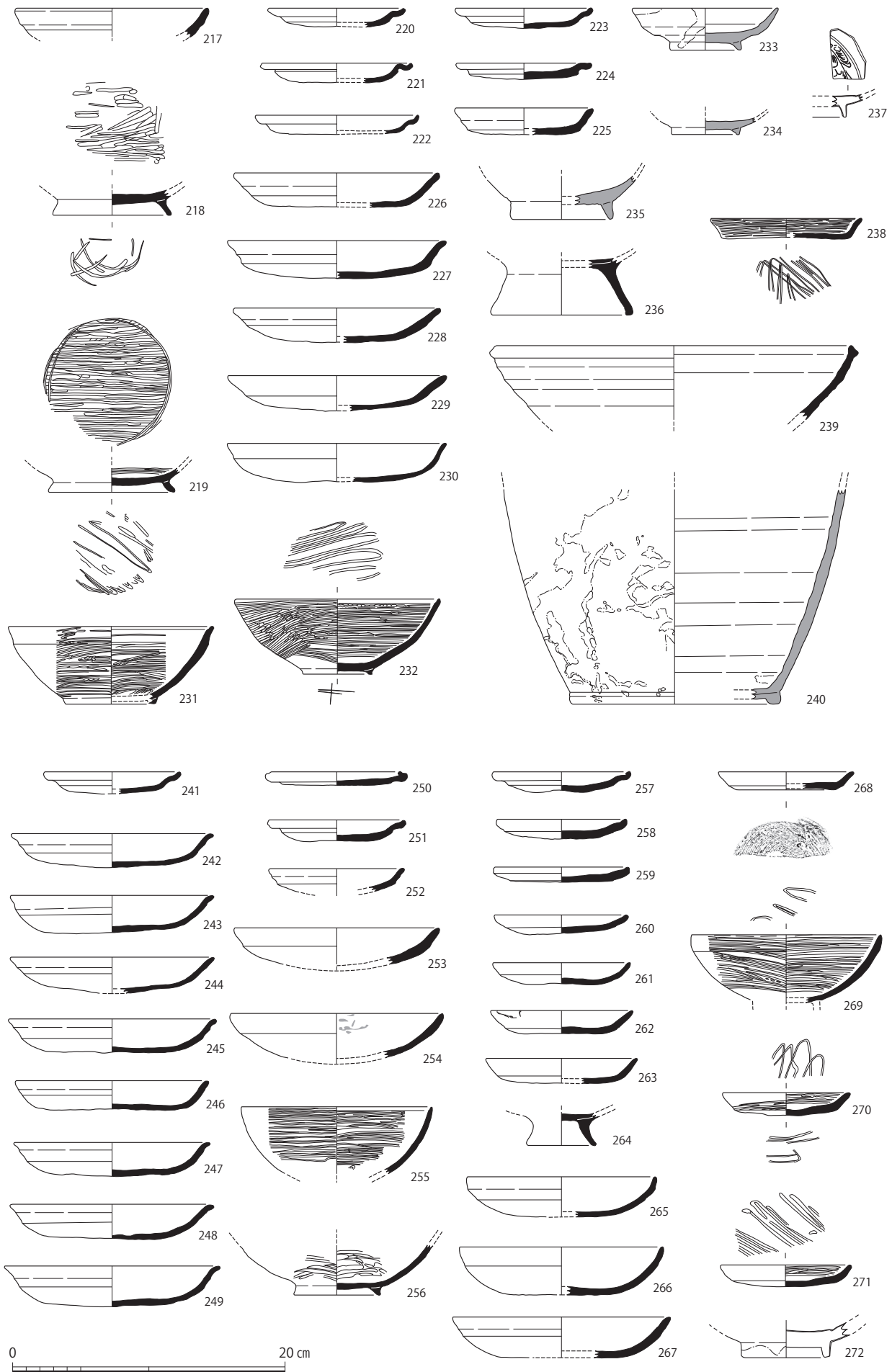

SG494 : 217 ~ 240、SX607 : 241 ~ 249、SD304 : 250 ~ 256 SG410 : 257 ~ 272

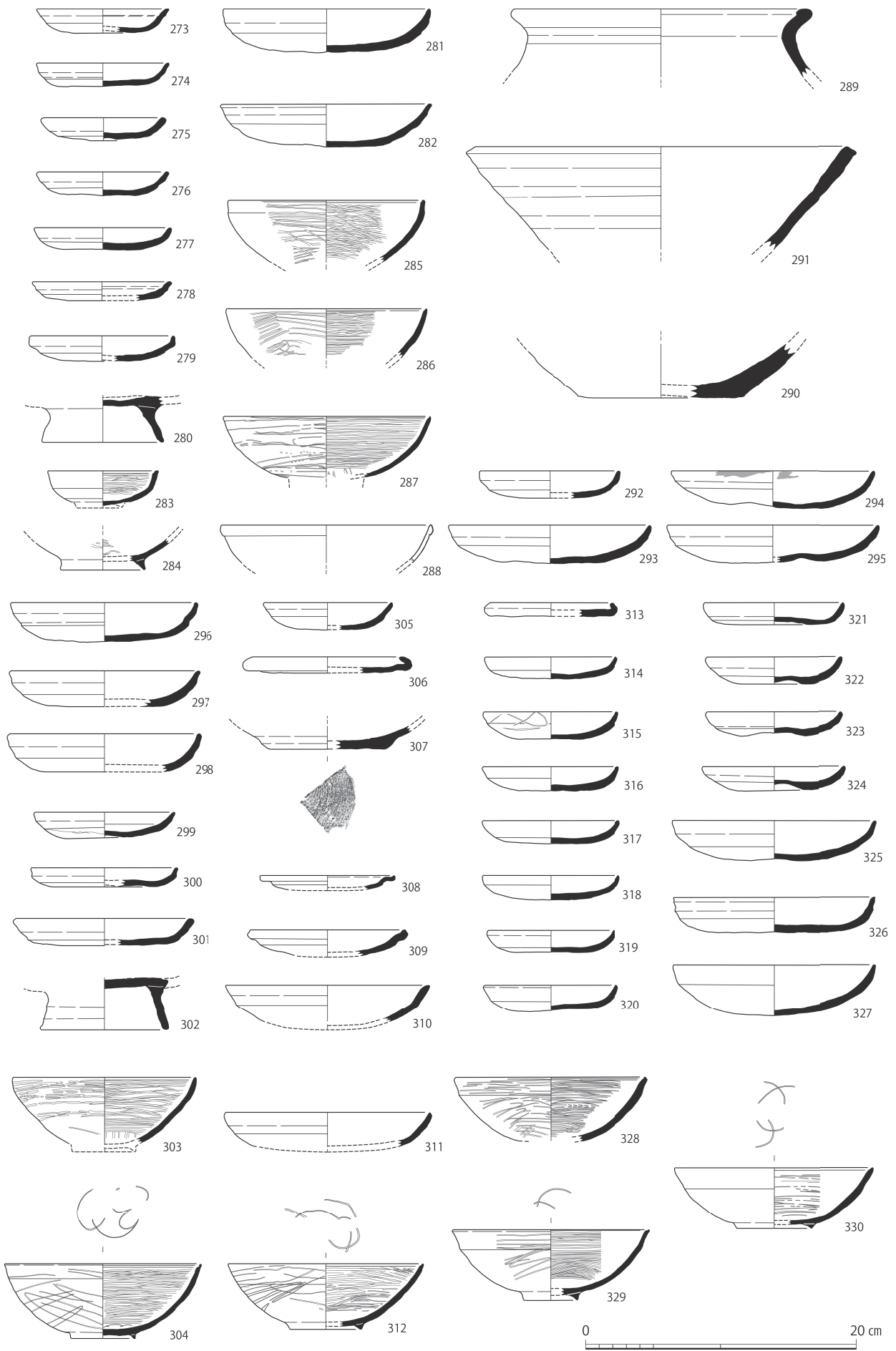

SE01 : 273 ~ 291、SP79 : 292 ~ 295、SD261 : 296 ~ 298、 SD262 : 299 ~ 304、
SD292 : 305 ~ 307、SE589 : 308 ~ 310、SP49 : 311・312、SK395 : 313 ~ 330

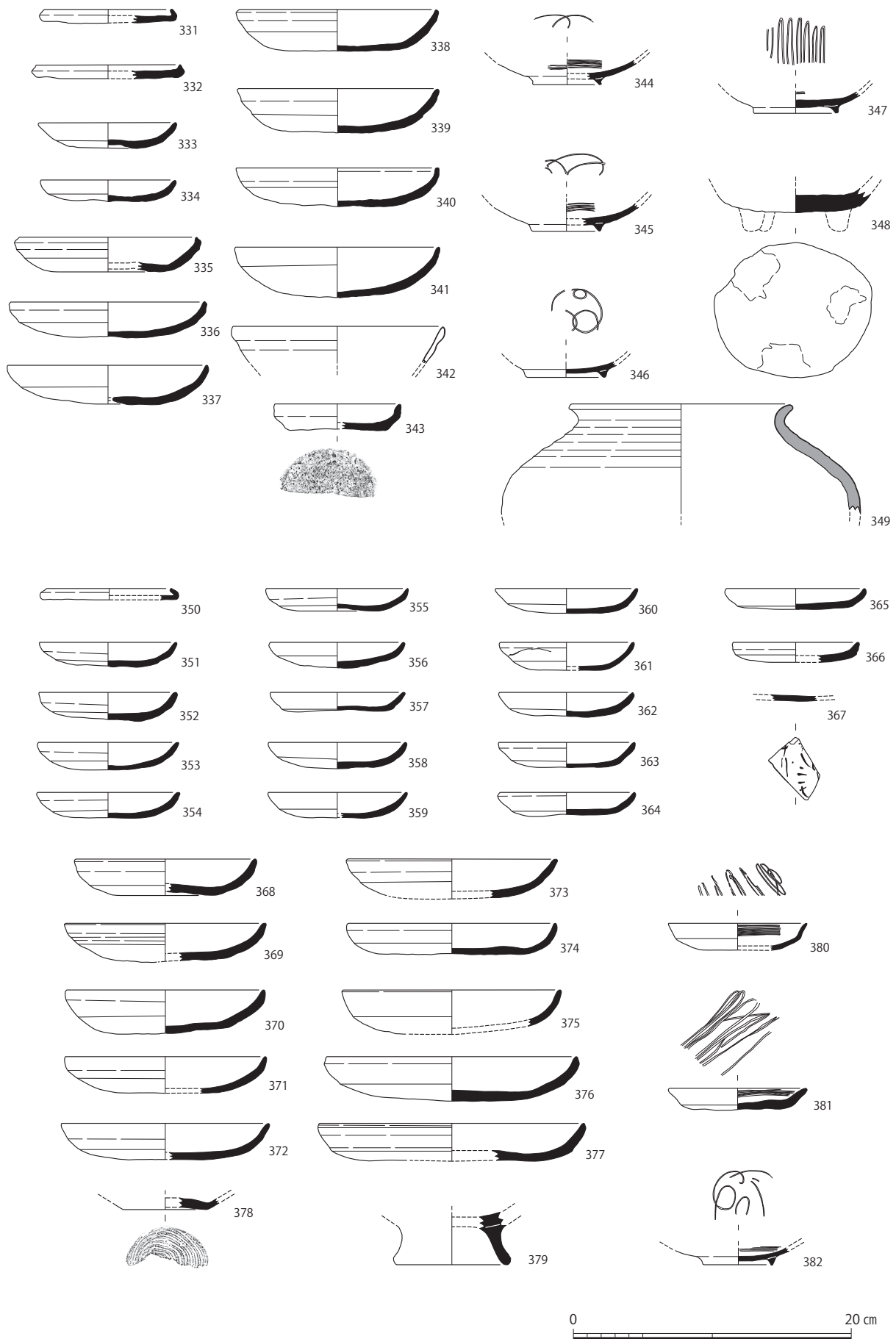

SK375 : 331 ~ 349、SK396 : 350 ~ 382

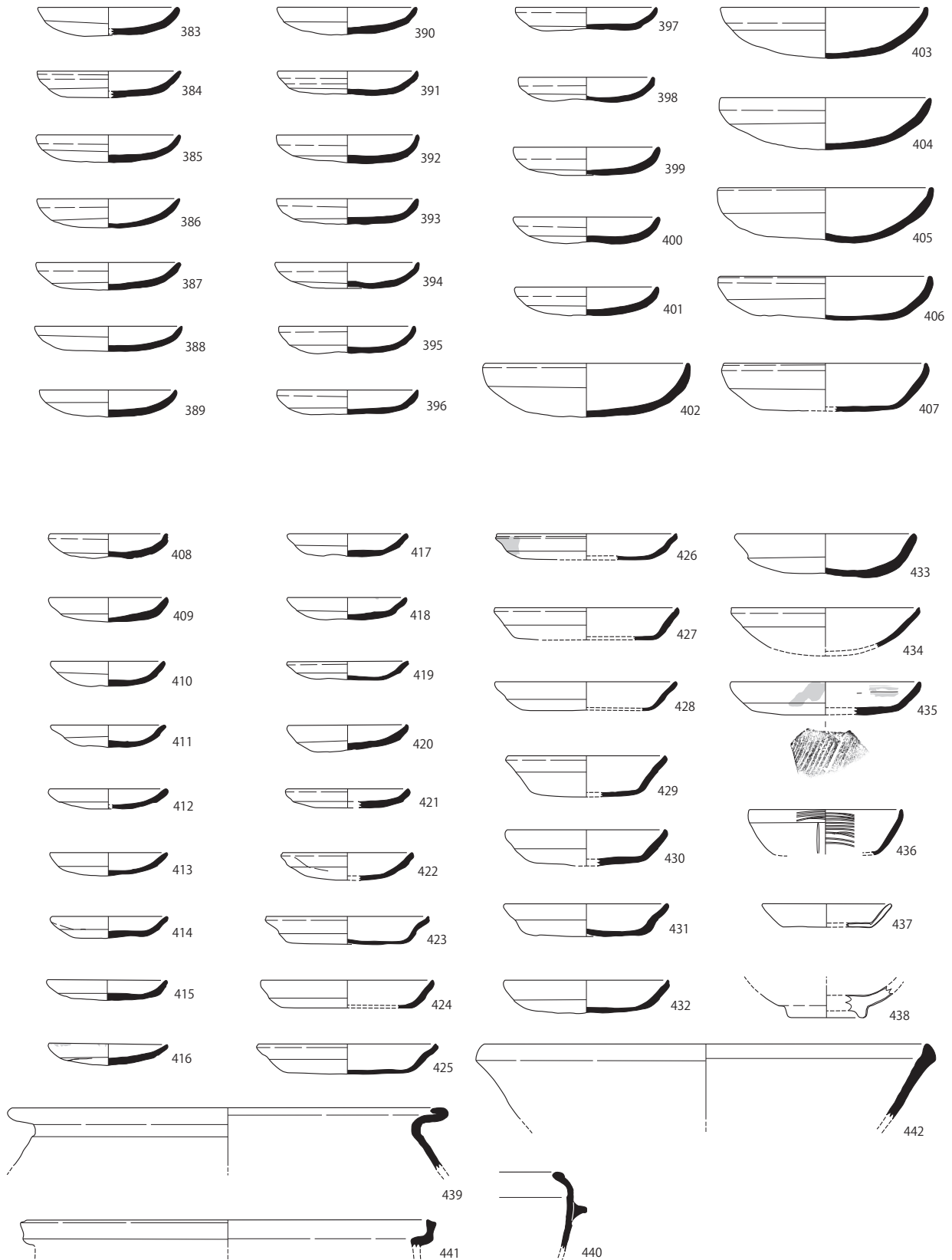

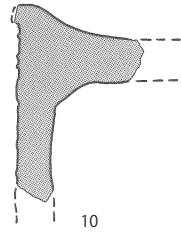
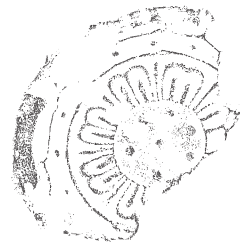
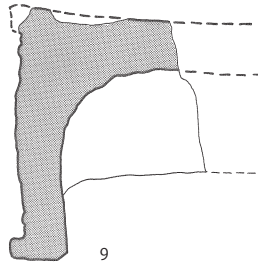
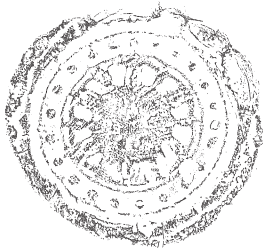
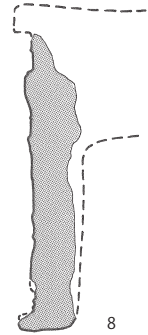
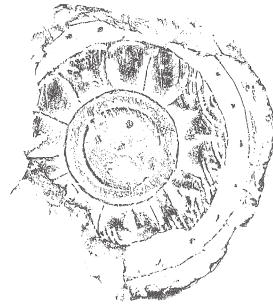
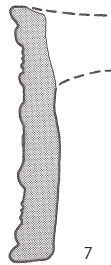
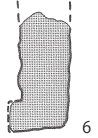
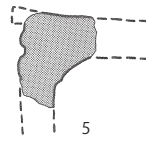
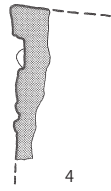
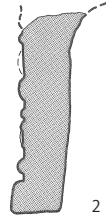
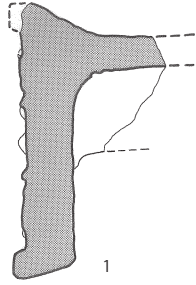

11

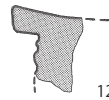
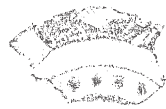

12

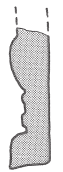
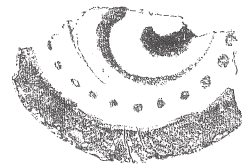

13



14

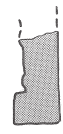

15



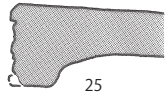
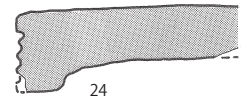
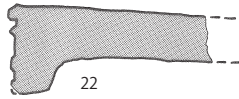
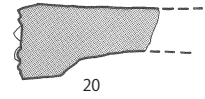
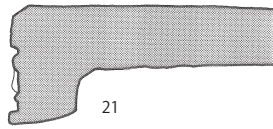
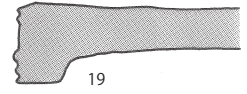
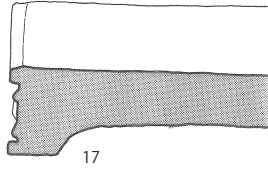
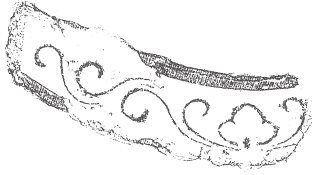
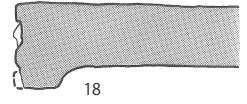
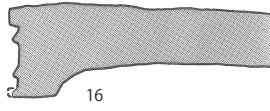

26

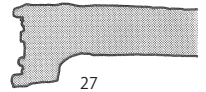

27

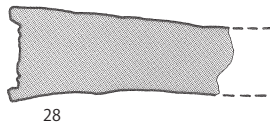

28

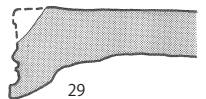

29

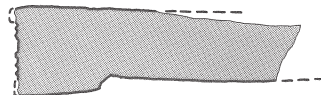
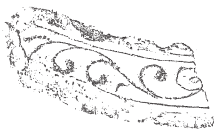

30

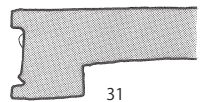

31



32

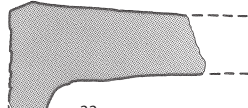

33

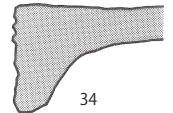

34



35

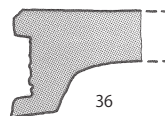

36

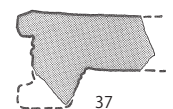

37

0 20 cm

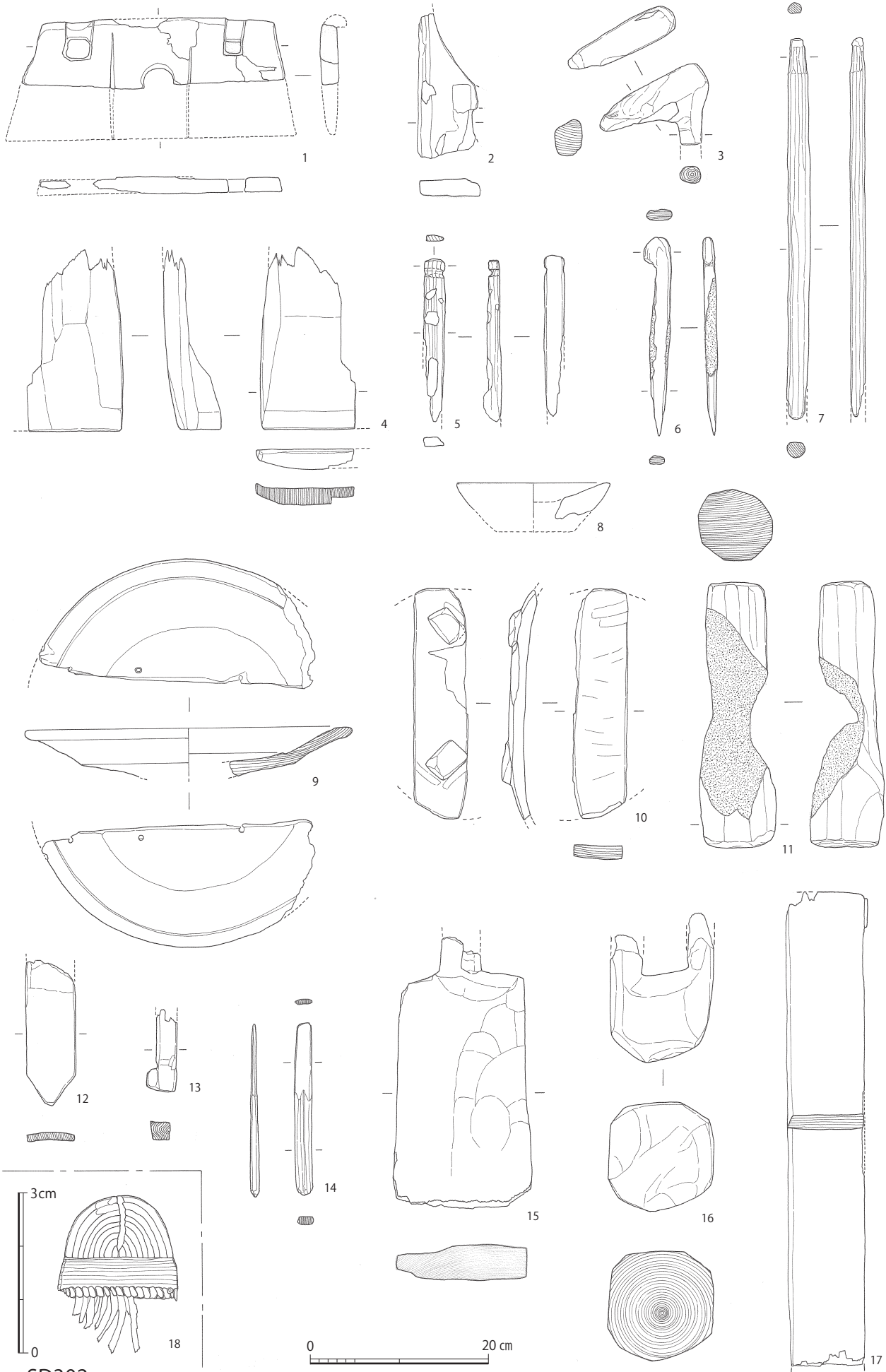

図面図版31 遺物(木製品) 実測図

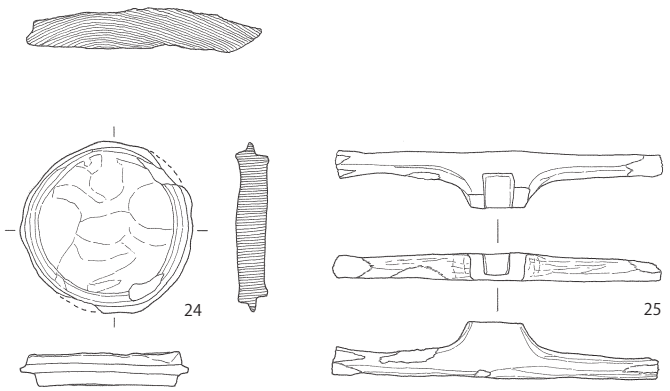
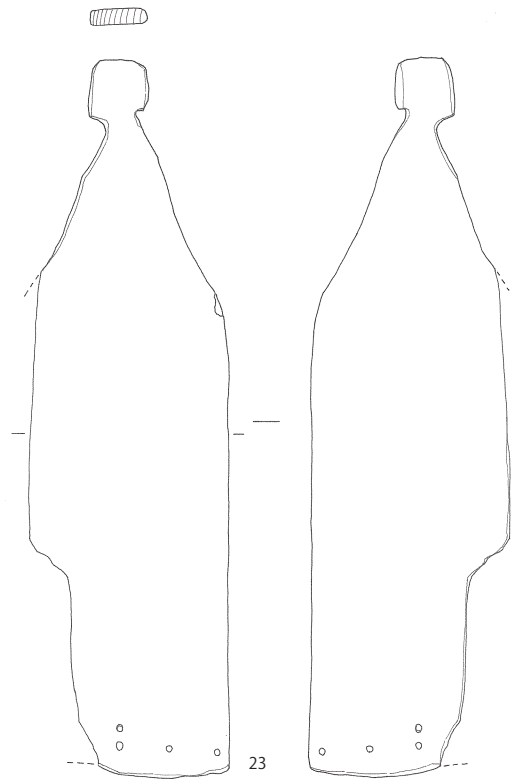
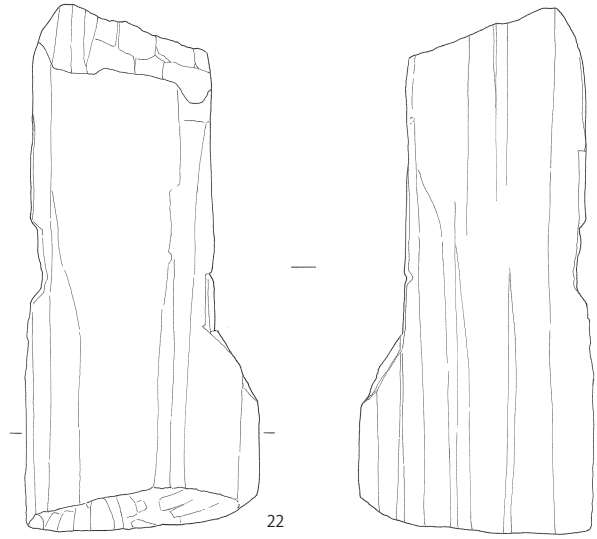
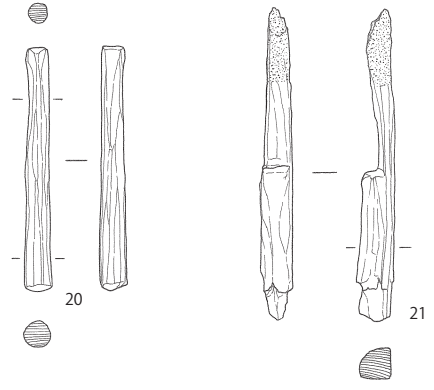
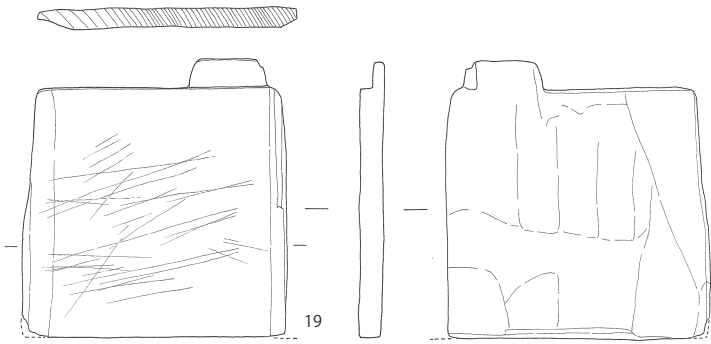

図面図版32 遺物(木製品)実測図

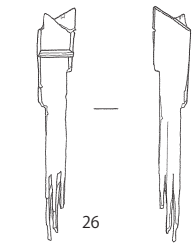

26

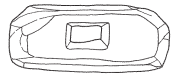

27

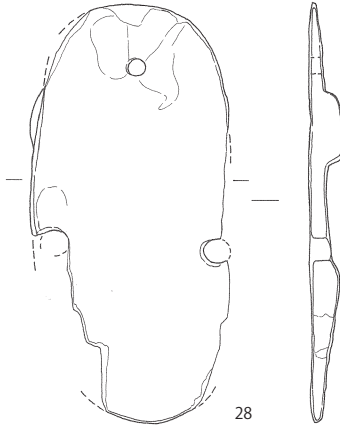

28

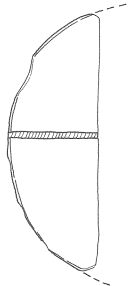
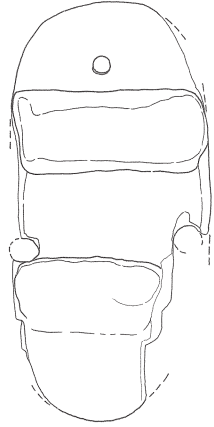

29

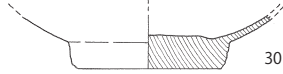

30

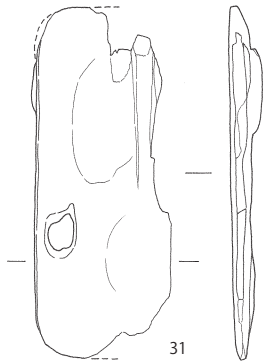

31

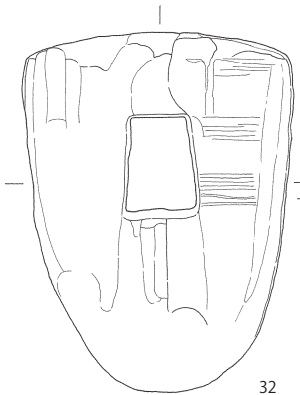

32

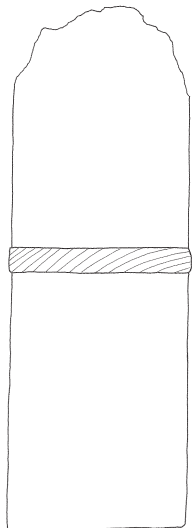
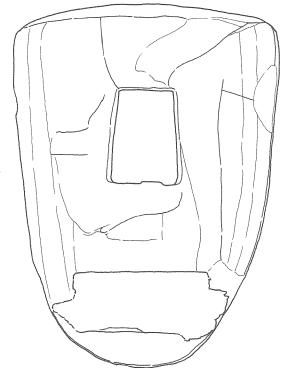

33

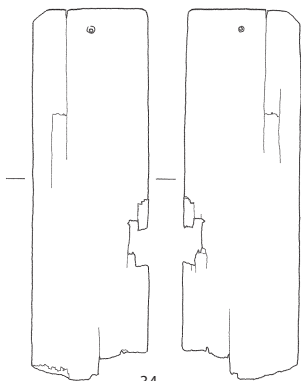
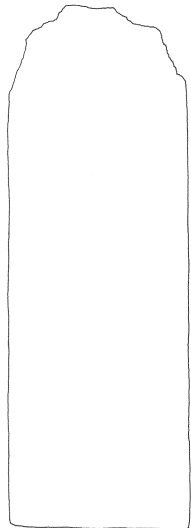

34

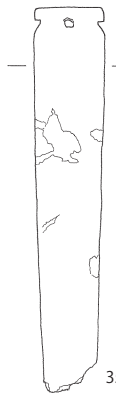

35

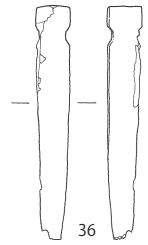

36

