

图面图版

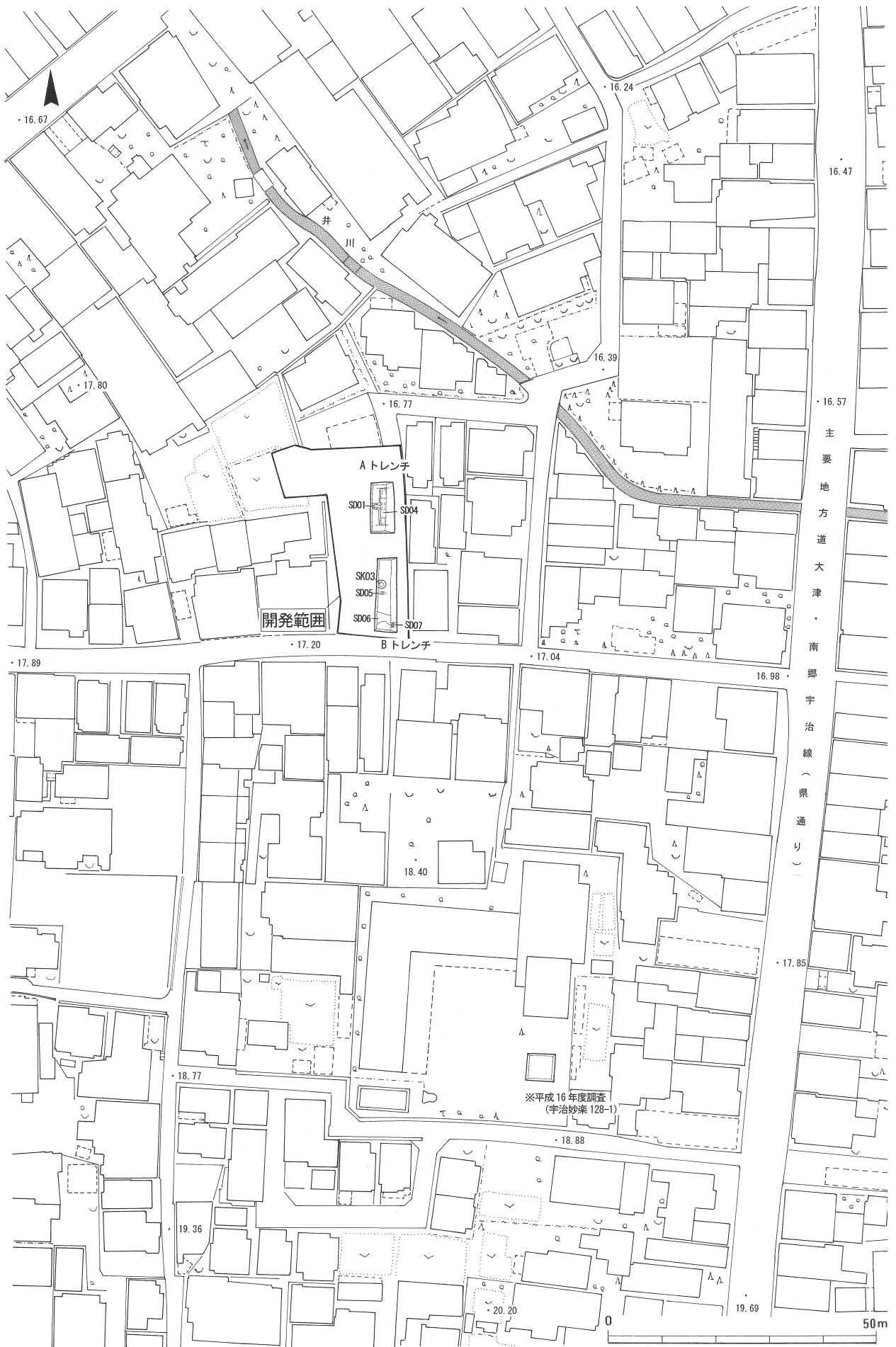







図面図版 4 Aトレンチ上層遺構・直下層石組実測図

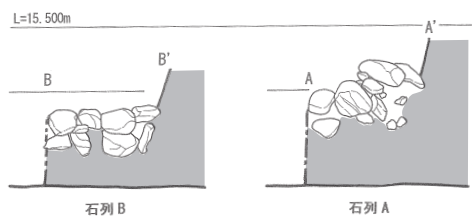
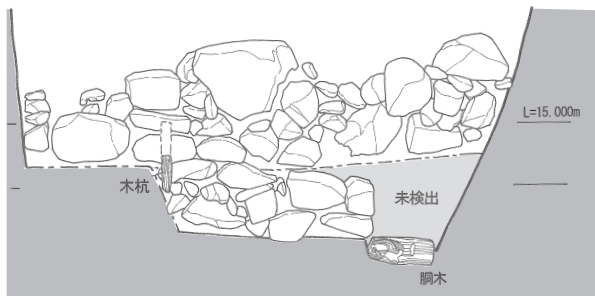
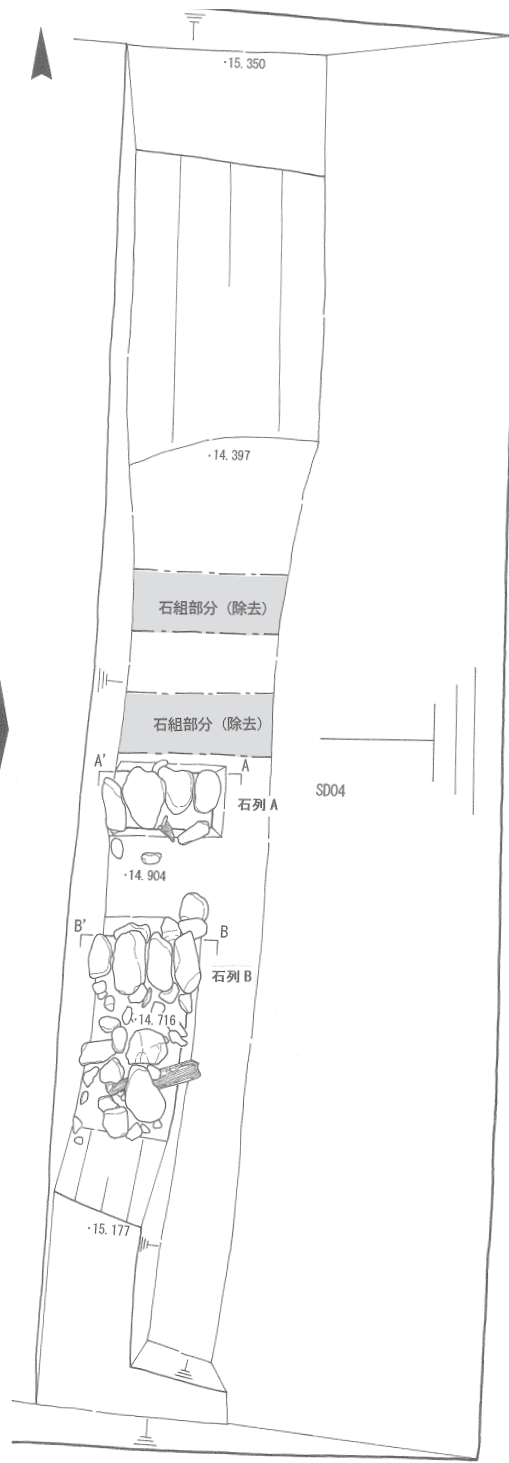
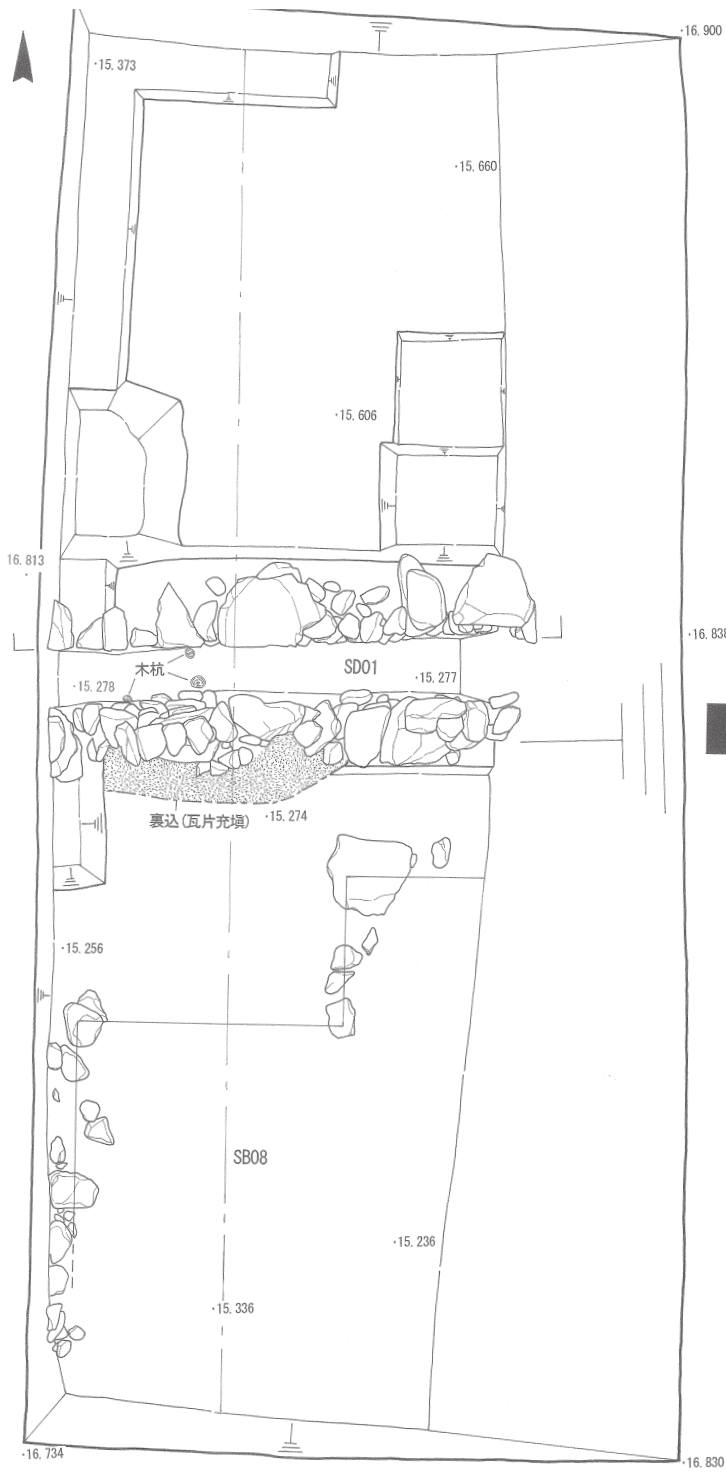

図面図版 5 A トレンチ下層遺構平面・東壁断面実測図

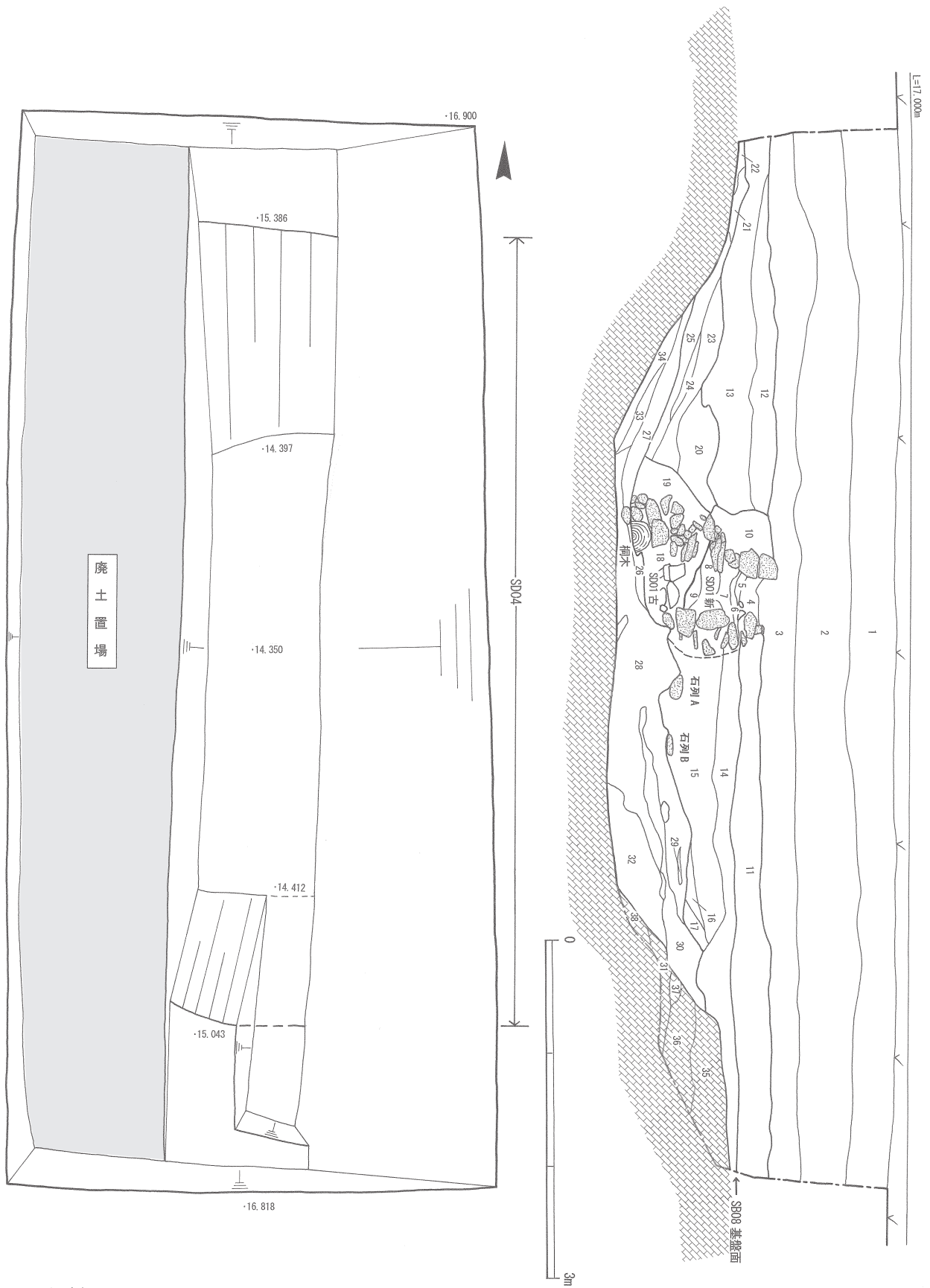

- |  |  |   |
|--|--|---|
| <ul style="list-style-type: none"> <li>1. 表土</li> <li>2. 褐灰色礫まじりシルト (灰・陶器片含む)</li> <li>3. 褐灰色砂礫まじりシルト (陶器片含む)</li> <li>4. にぶい褐色砂層</li> <li>5. 褐灰色土 (砂粒多く含む)</li> <li>6. 明褐色砂層</li> <li>7. 褐灰色土 (瓦片含む)</li> <li>8. 灰褐色砂層 (木片含む)</li> <li>9. 褐灰色土</li> <li>10. 黒褐色細砂まじりシルト (裏込石含む)</li> <li>11. 褐灰色土 (部分的に焼土・陶器片含む)</li> <li>12. 褐灰色砂まじり土 (部分的に焼土・陶器片含む)</li> <li>13. 灰褐色礫まじり砂層 (瓦片・焼土含む) 15層相当層?</li> </ul> | <ul style="list-style-type: none"> <li>14. 褐灰色土 (小礫・炭を含む)</li> <li>15. 褐灰色礫まじり砂層</li> <li>16. 黄褐色礫まじりシルト</li> <li>17. 黒褐色礫まじり粘質土</li> <li>18. 褐灰色砂まじり土</li> <li>19. 褐灰色礫まじり砂質土</li> <li>20. 褐色砂礫まじり土 (褐灰色シルトのブロックを含む)</li> <li>21. 褐灰色砂層</li> <li>22. 明褐色土</li> <li>23. 褐灰色礫まじり土</li> <li>24. 褐灰色砂まじりシルト</li> <li>25. 褐色砂まじりシルト</li> <li>26. 灰褐色礫まじりシルト</li> </ul> | <ul style="list-style-type: none"> <li>27. 灰色粘質土</li> <li>28. 黒褐色粘質土 (木片・炭・小礫含む)</li> <li>29. 黒褐色礫まじりシルト</li> <li>30. 黒褐色砂まじりシルト</li> <li>31. 褐灰色砂まじりシルト</li> <li>32. 黒褐色砂礫まじりシルト</li> <li>33. 灰白色砂層</li> <li>34. 黒褐色砂まじりシルト</li> <li>35. 灰褐色礫まじり砂層</li> <li>36. 灰黄色礫まじり砂層</li> <li>37. 灰褐色砂層</li> <li>38. 黄褐色礫まじり砂層</li> </ul> |
|--|--|---|



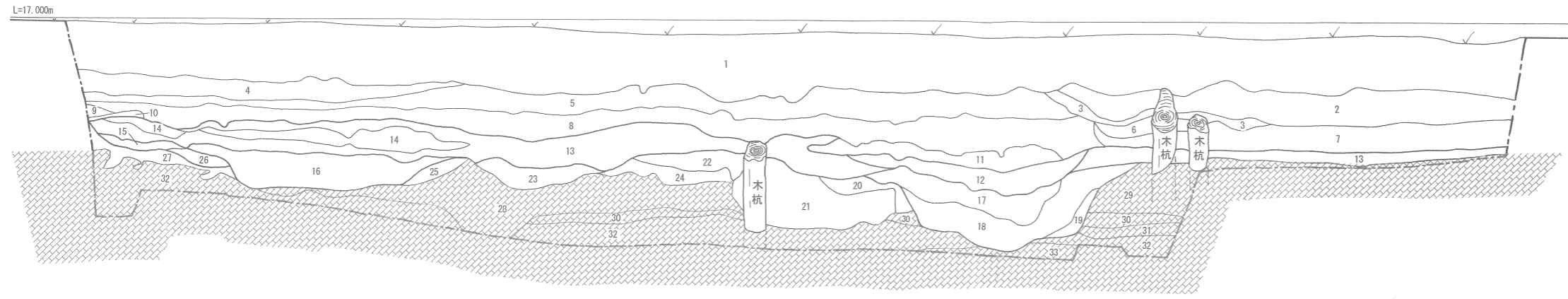

1. 表土
2. 黒色土(火災層)
3. 褐灰色砂層(瓦片含む)
4. 灰褐色砂まじりシルト(灰・木片・瓦等含む)
5. 褐灰色土(炭・陶器片含む)
6. 褐灰色砂まじりシルト
7. 灰色砂まじりシルト
8. 褐灰色土(陶器片含む)(灰色土ブロックを含む)
9. 灰色土(ブロック土)
10. 褐灰色土(ブロック土?)
11. 灰色シルト
12. オリーブ黒色土(SK03埋土)
13. 褐灰色土(焼土層・陶器片・瓦多く含む)
14. 灰黄褐色砂礫層
15. 淡茶褐色礫まじり土
16. 褐灰色礫土
17. 褐灰色礫まじり土(木片多く含む)
18. 褐灰色礫まじり土(陶器片含む)(33層ブロック含む)
19. 灰色砂層(SK02埋土)
20. 灰白色砂礫層
21. 褐灰色砂礫層(シルトブロック含む)
22. 褐灰色礫まじり土(焼土含む)
23. 明褐灰色砂礫層(陶器片等含む)
24. 灰色シルト(炭・木片・砂粒含む)
25. にぶい褐色シルト
26. 褐灰色砂礫層(SK07埋土か)
27. 褐灰色砂層
28. 灰褐色砂礫層
29. 灰色砂礫層
30. 褐灰色シルト(植物遺存体含む)
31. 褐灰色シルト(植物遺存体含む)
32. 褐灰色砂まじりシルト
33. 褐灰色粘質土

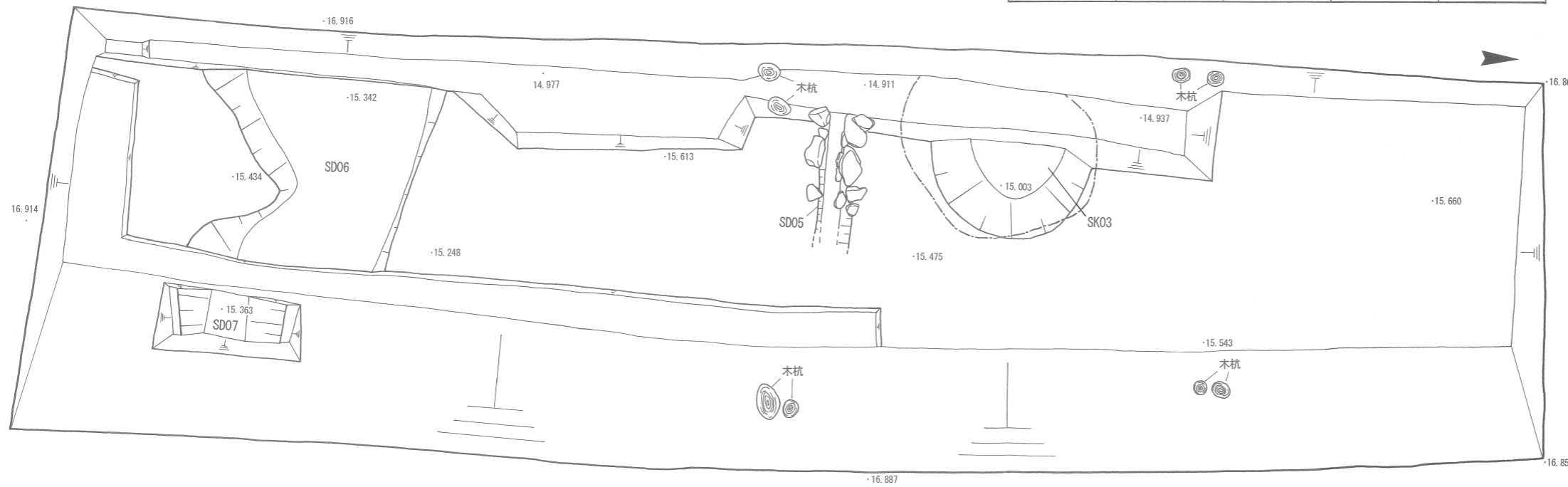



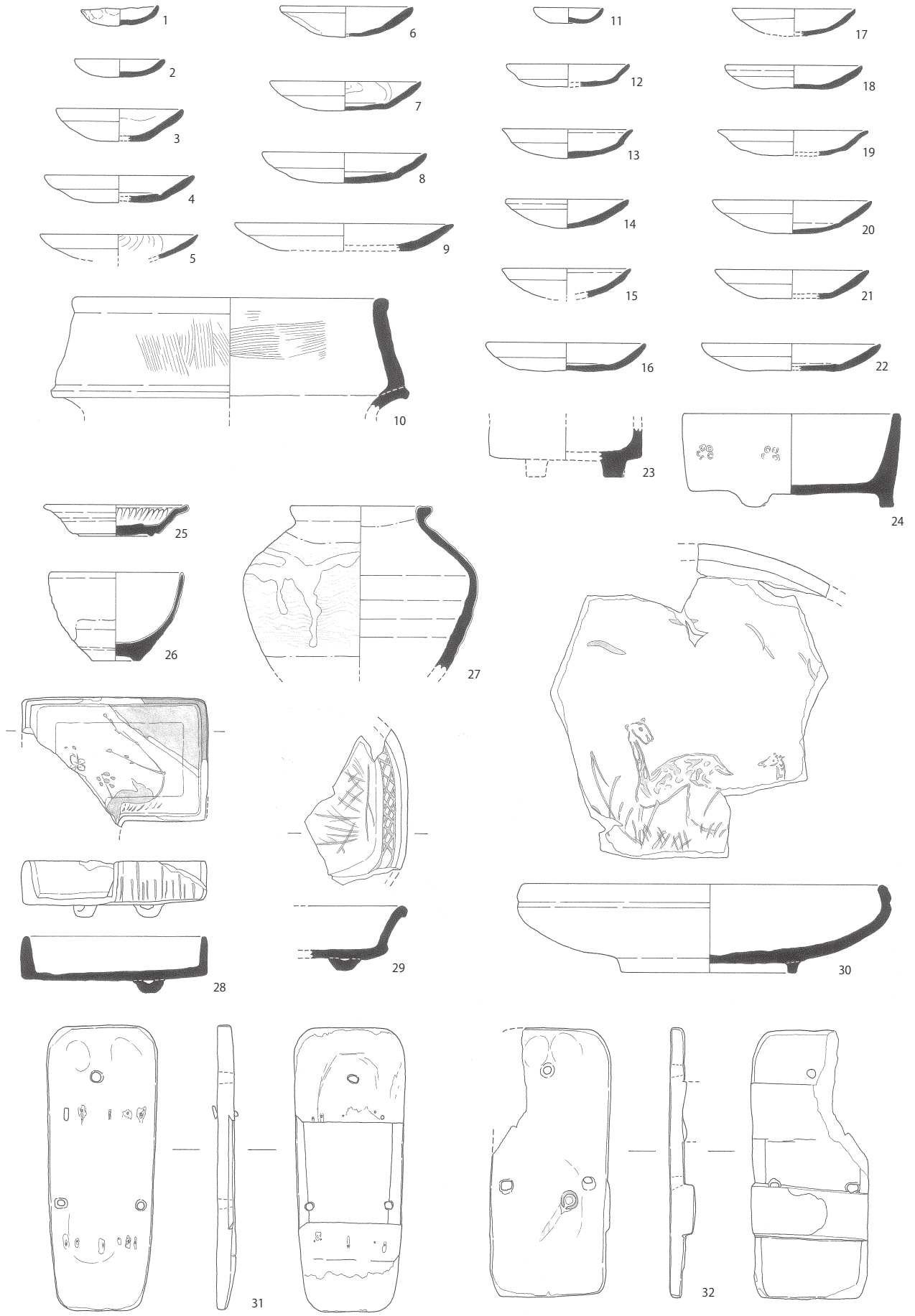

0 20 cm

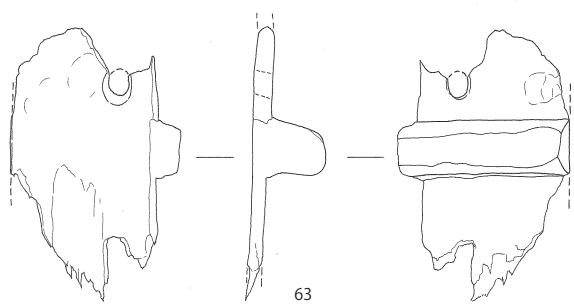
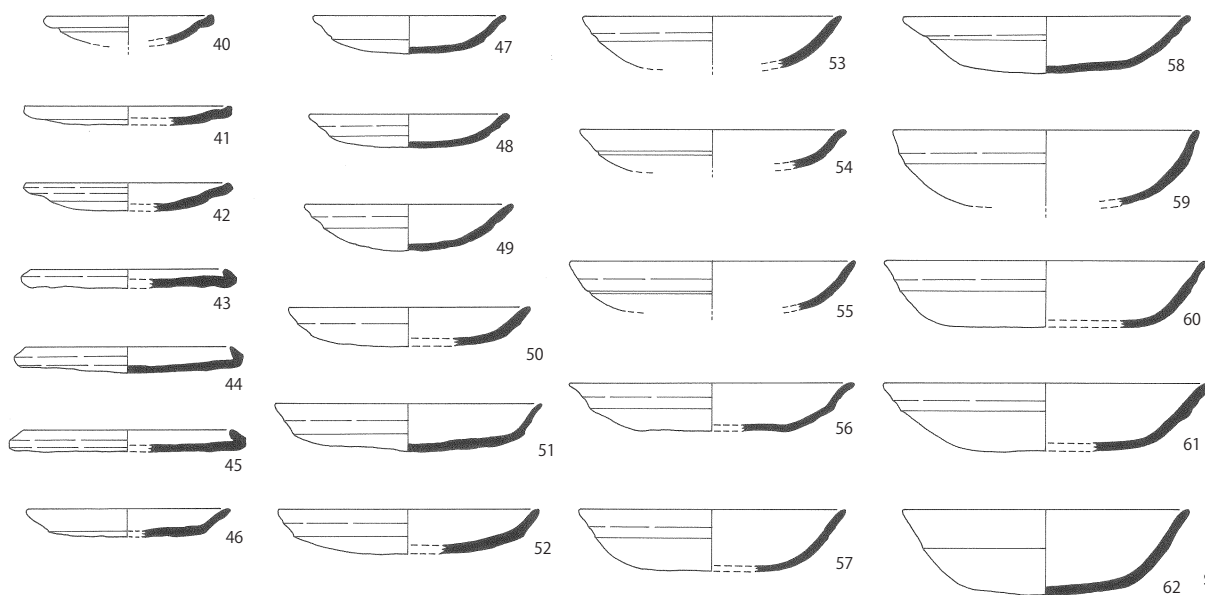
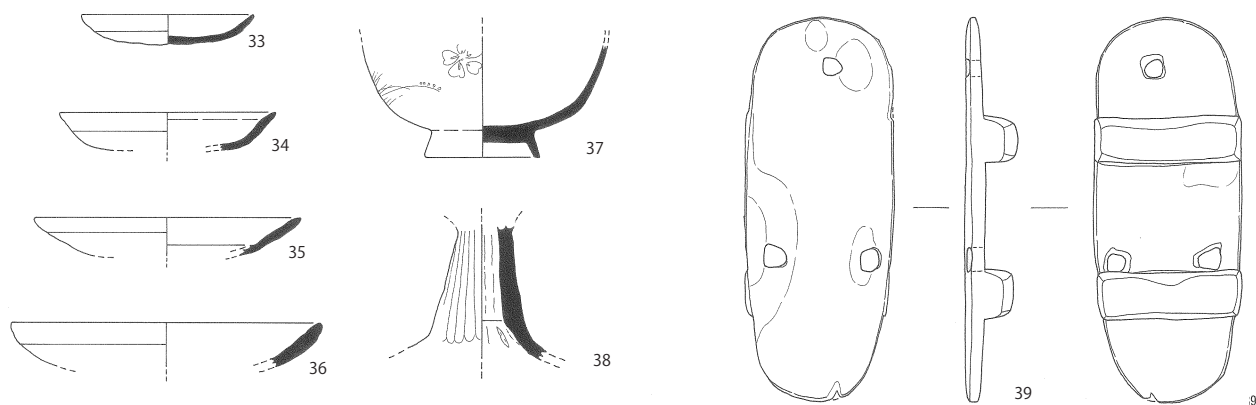

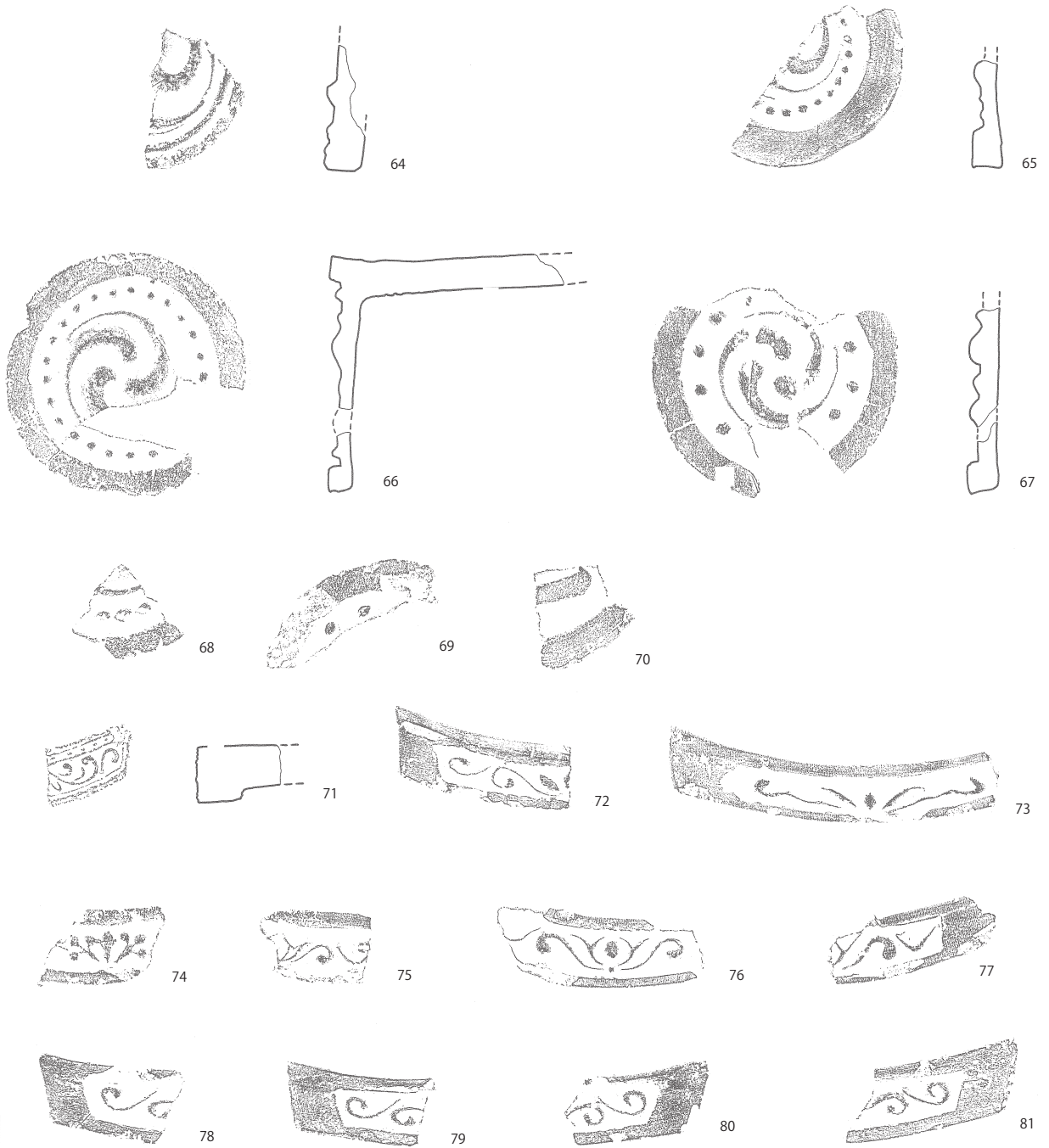

0 20 cm

図面図版 10 トレンチ平面・西壁断面実測図

1. 黄褐色砂層 (黄土)
2. 黄褐色砂質土 (表土)
3. 黒褐色腐まじり砂質土
4. 黒褐色シルト
5. 黒褐色腐まじり粘土
6. 黄褐色腐まじり粘質土 (SK15埋土・瓦多く含む)
7. 黄灰色シルト (SK16埋土・建物含む)
8. 黒褐色腐まじりシルト
9. 黒褐色シルト
10. にぶい黄褐色粘土
11. 黄褐色粘土 [地山]

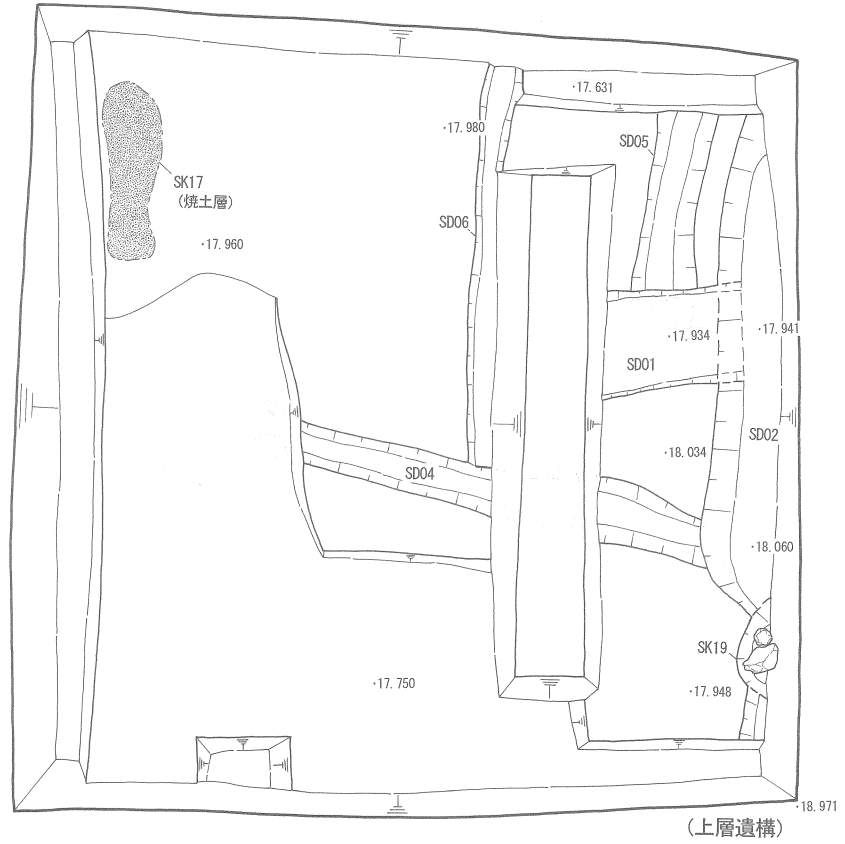
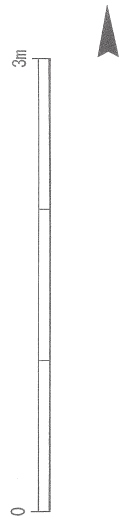

(上層遺構)

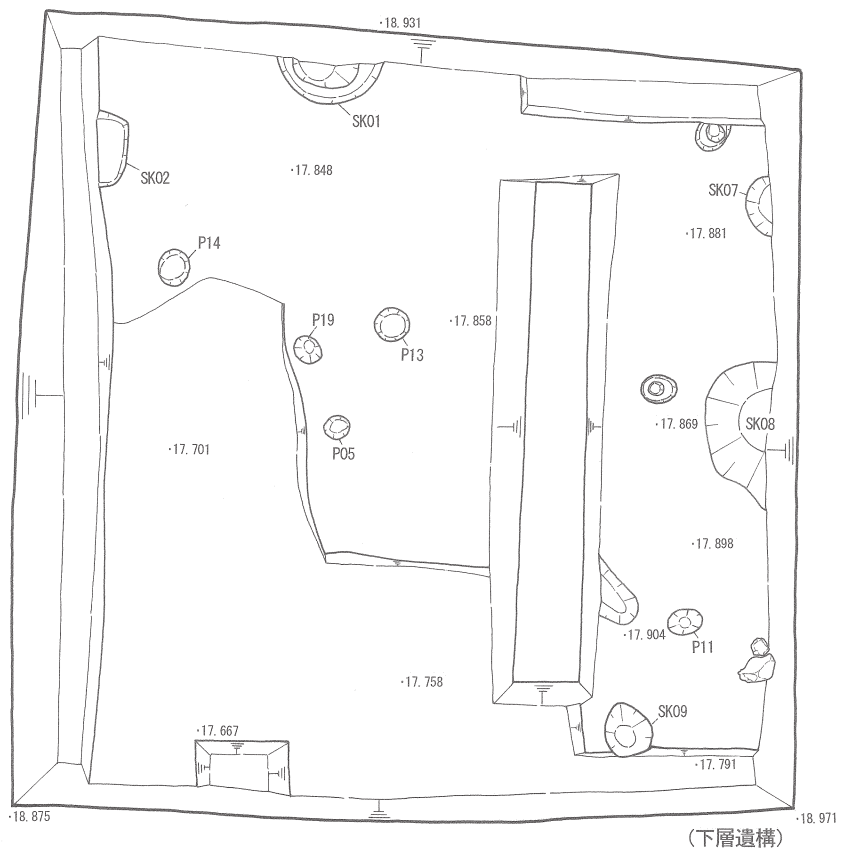
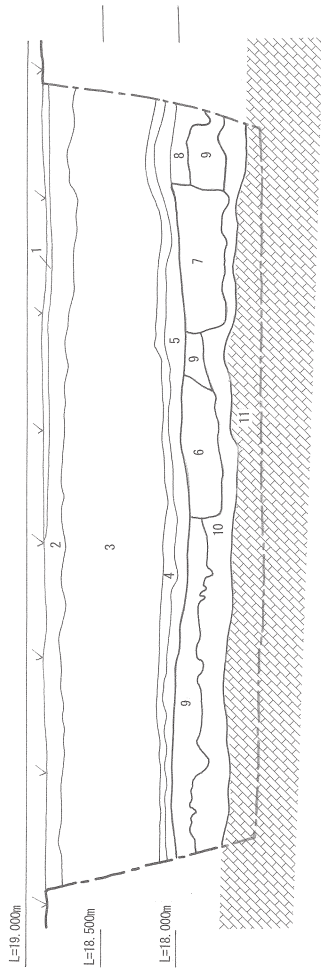

(下層遺構)

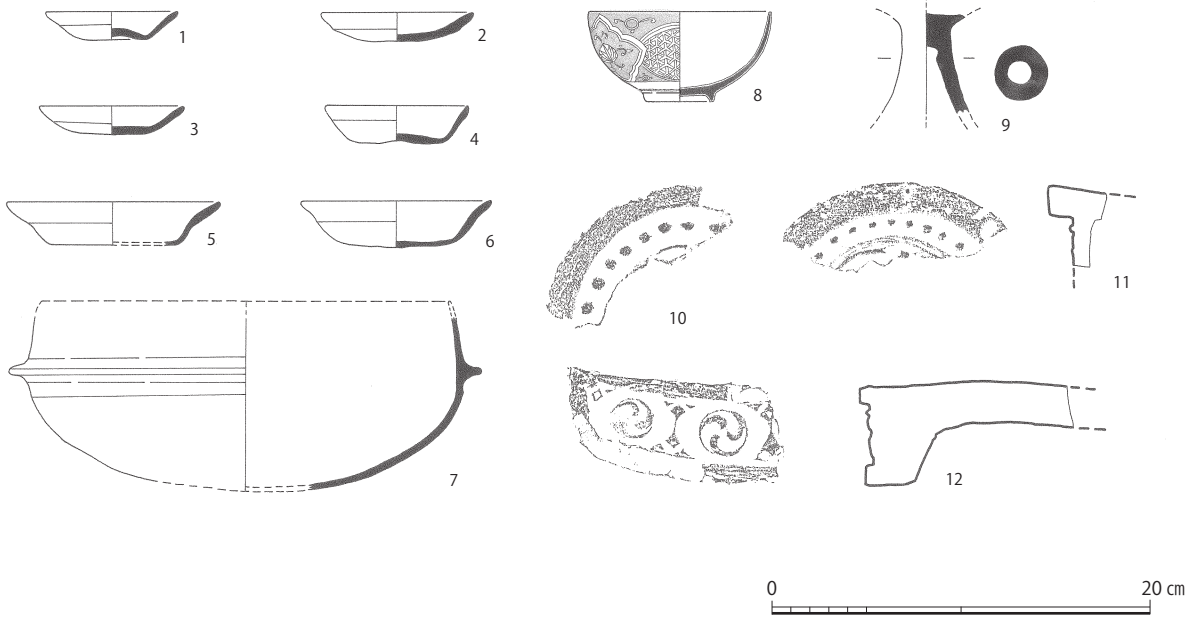



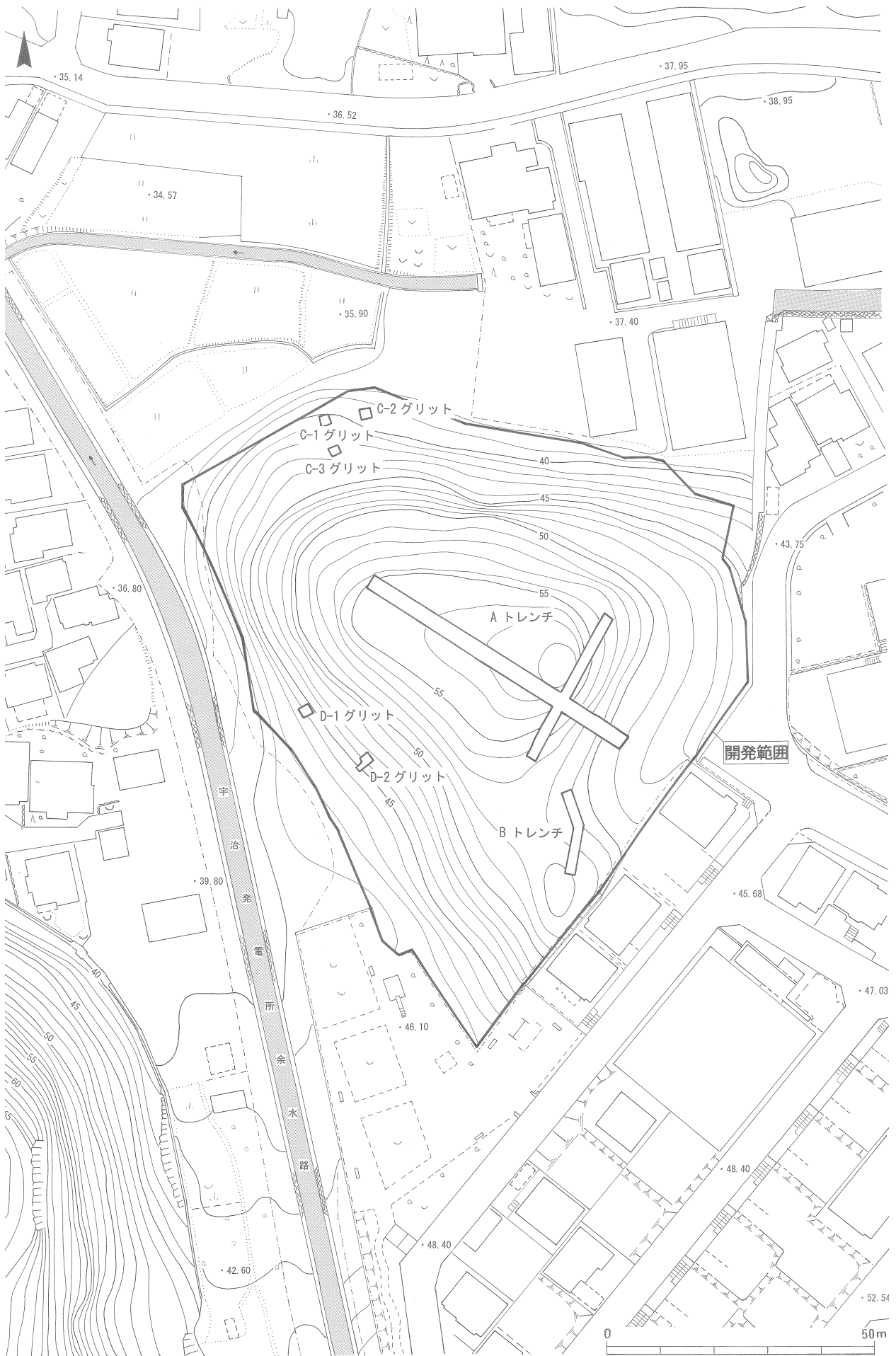



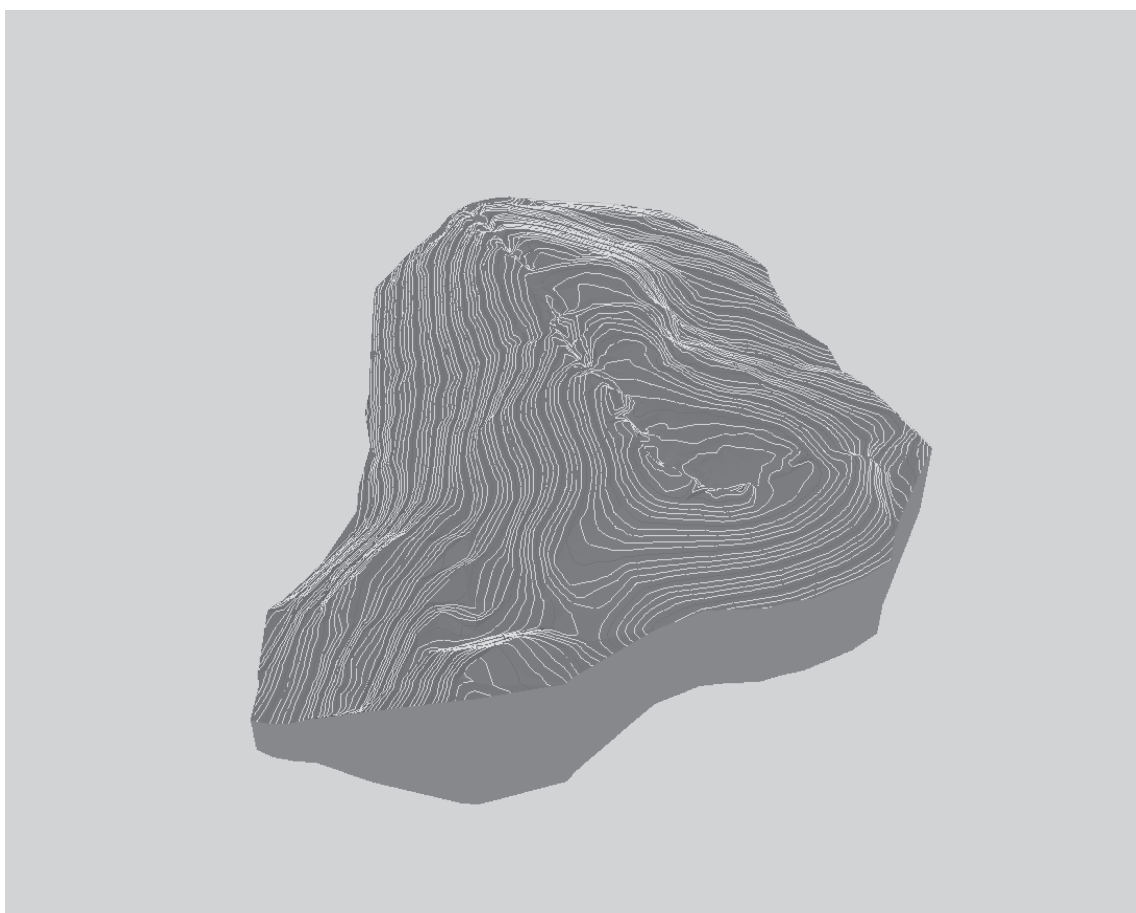
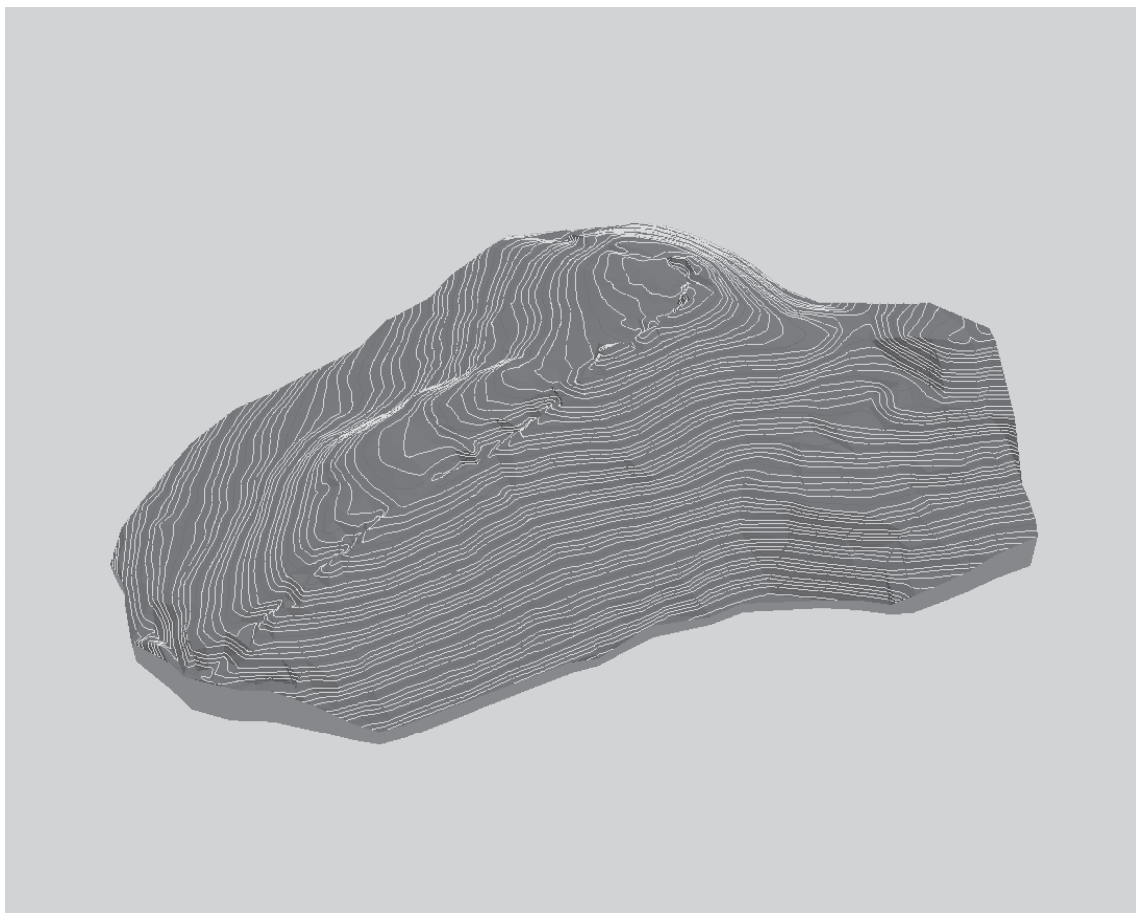





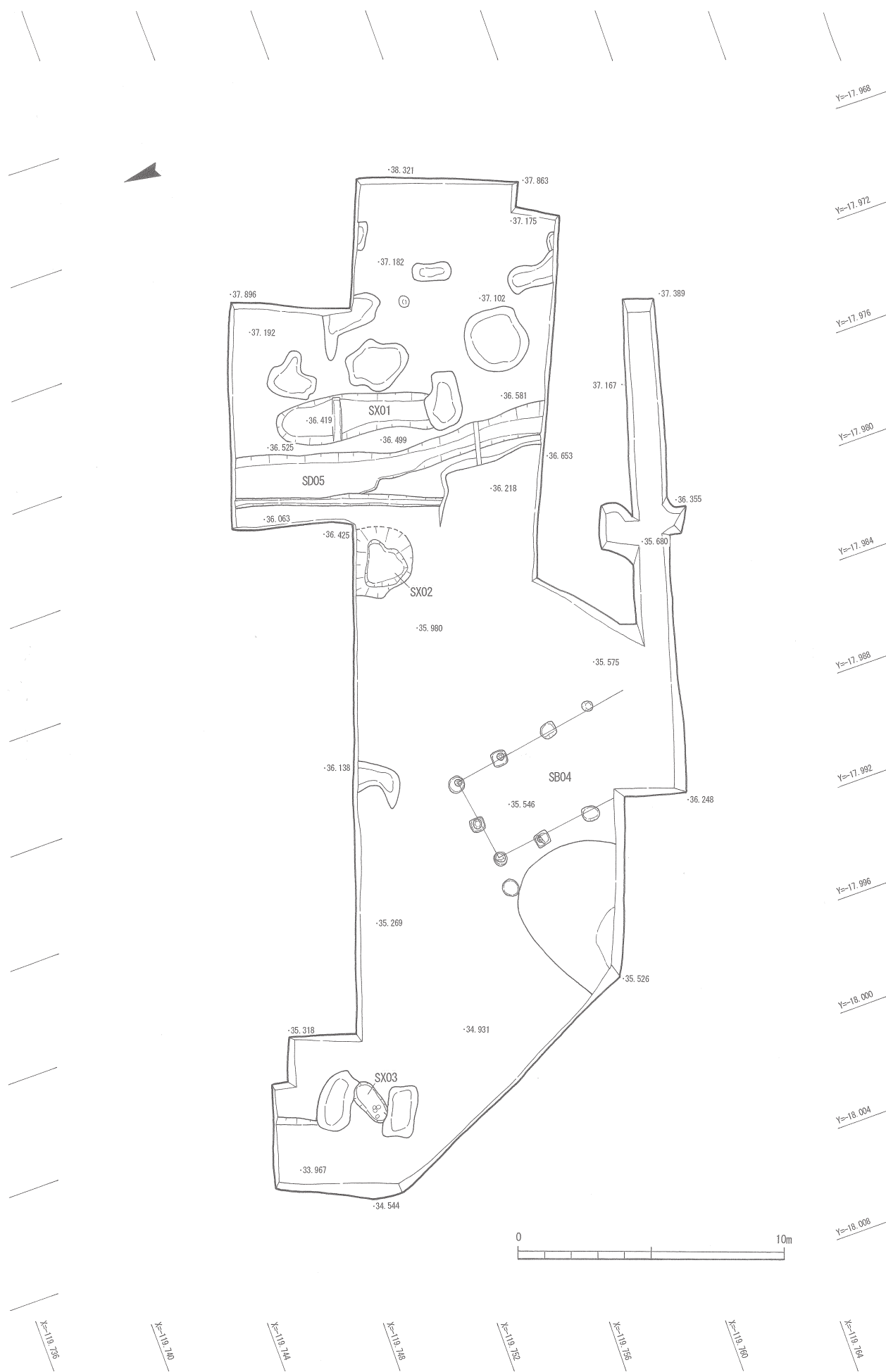
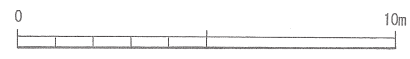
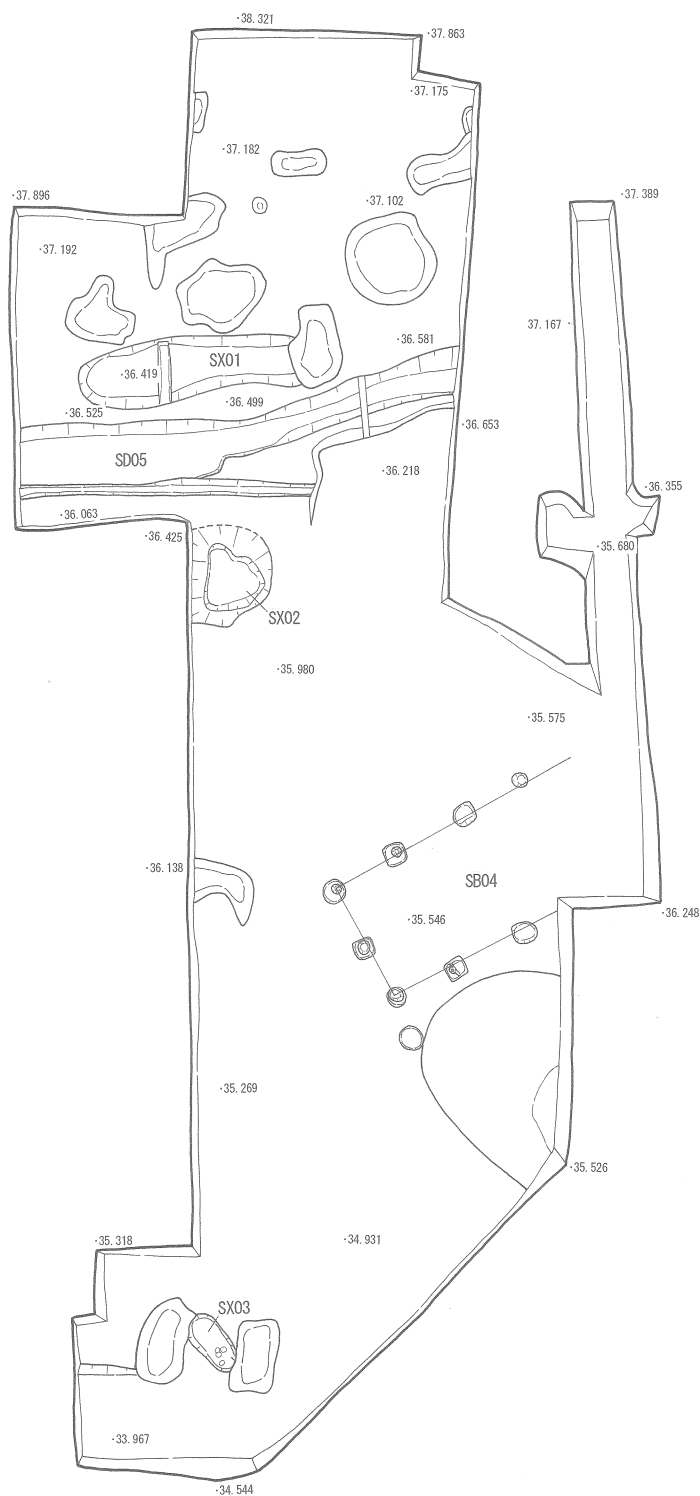

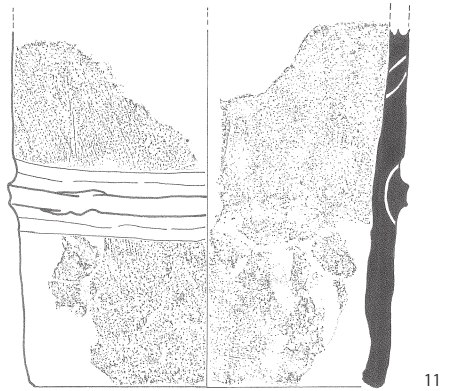
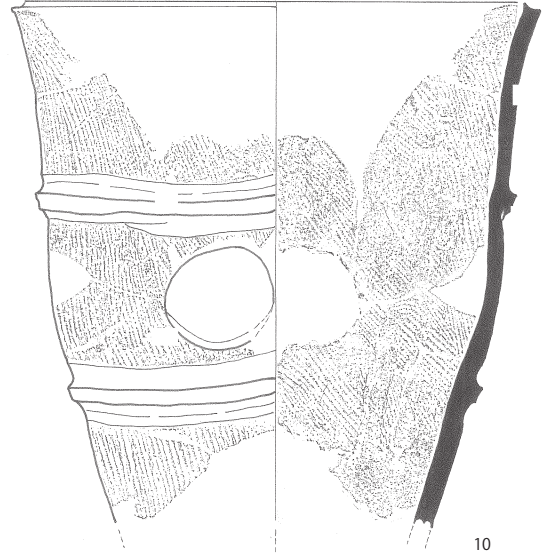
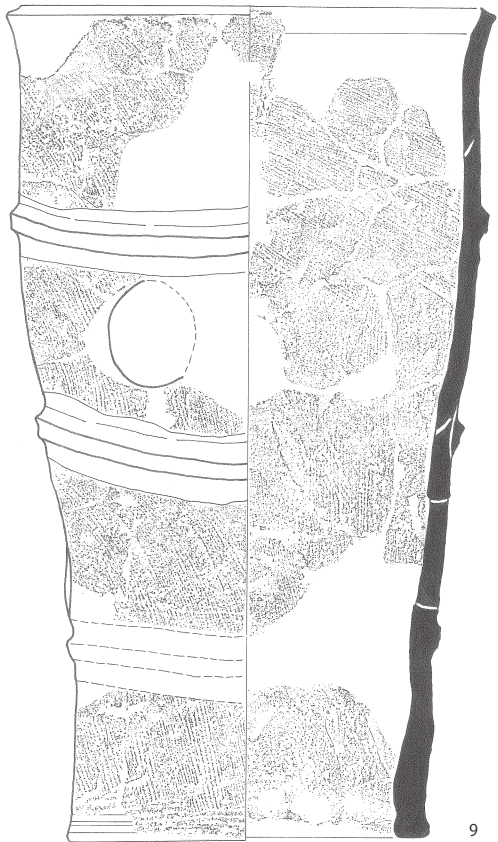
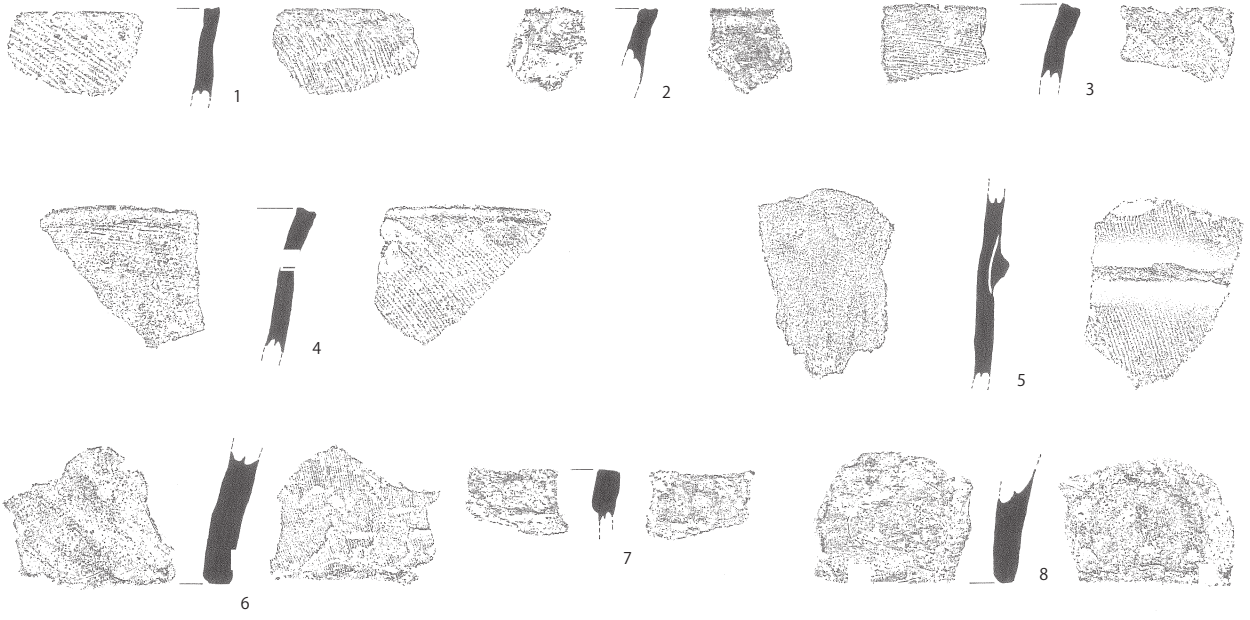

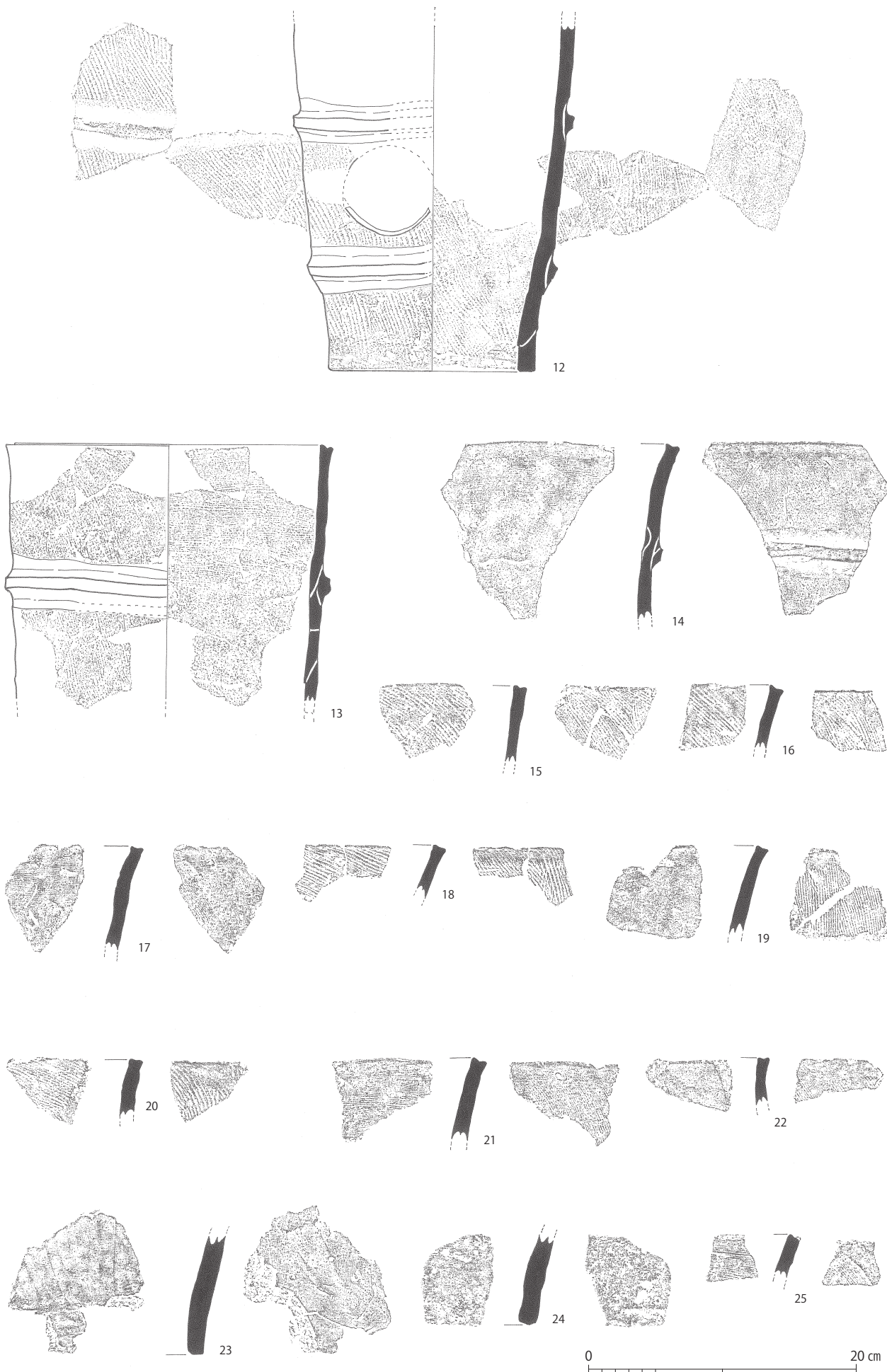

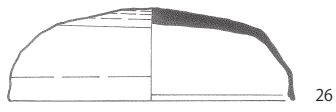

26

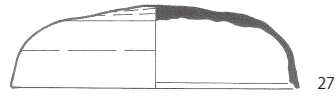

27

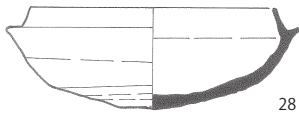
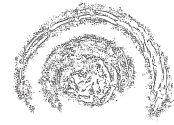

28

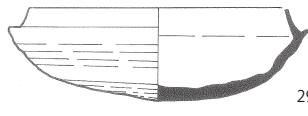

29

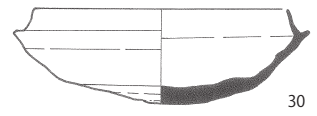

30

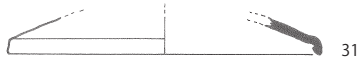

31



※平成16年度調査（木幡北山畑24他）

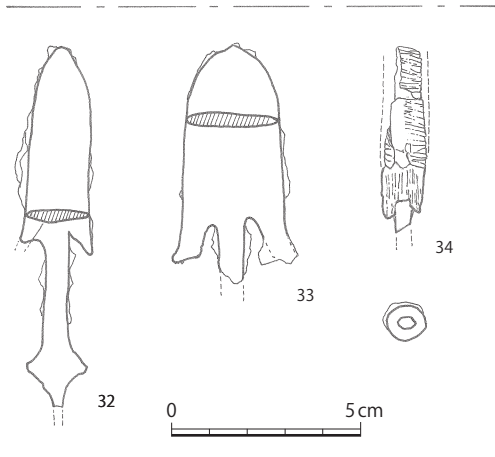

34

33

32

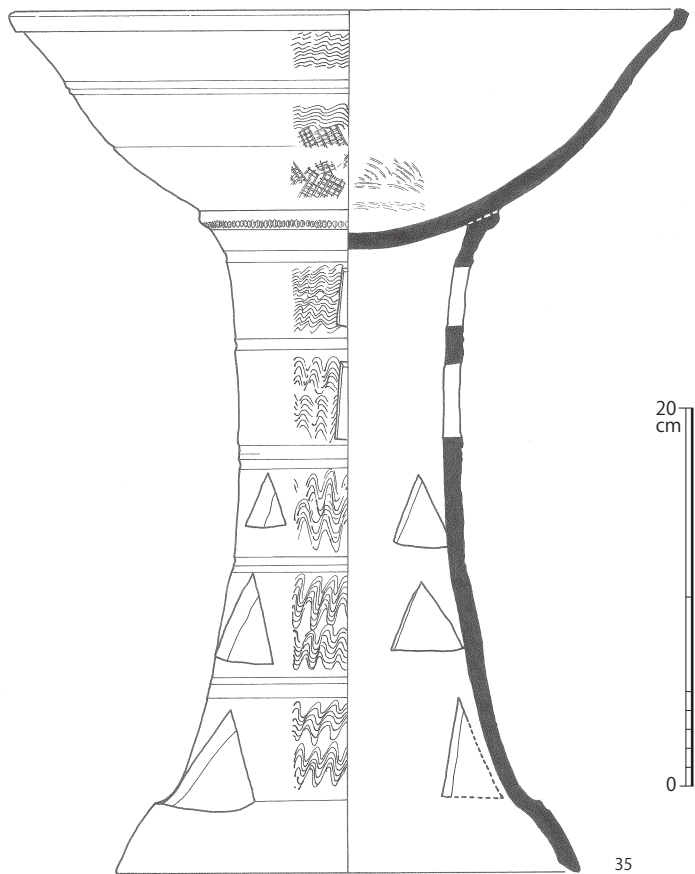

20 cm

0

35

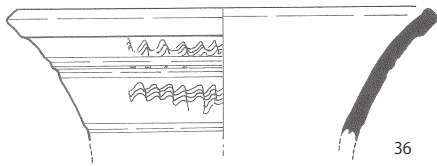

36

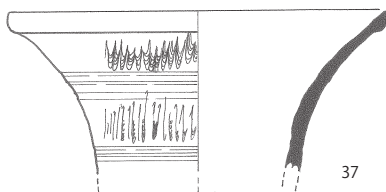

37

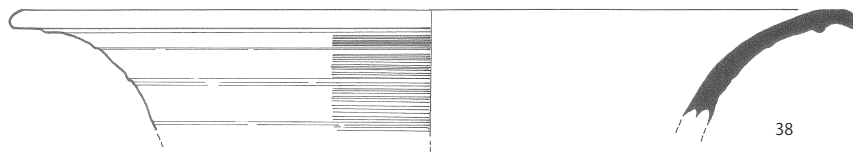

38

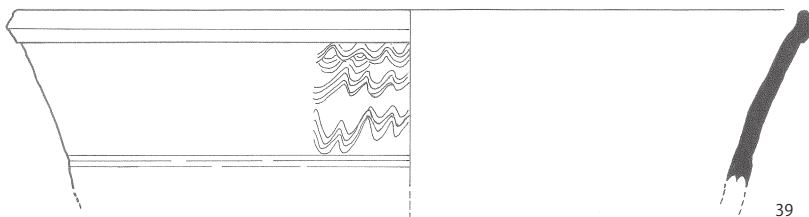

39

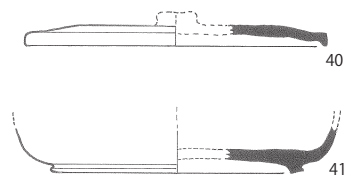

40

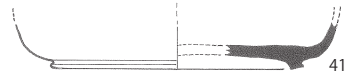

41

