

別図 1

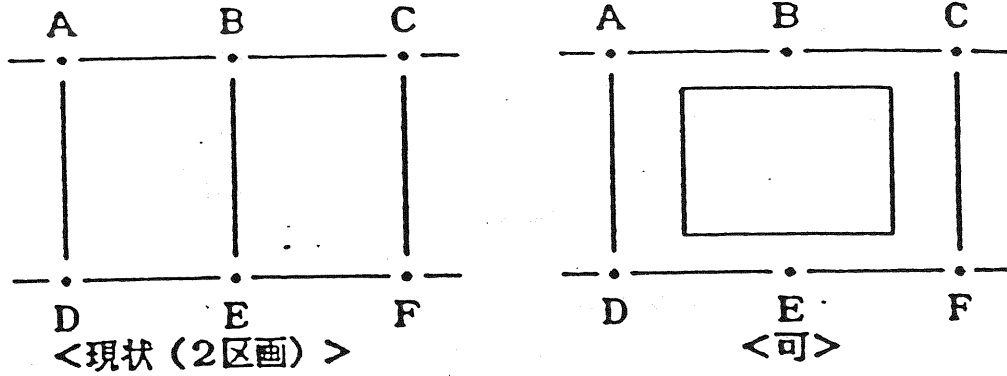

別図 2

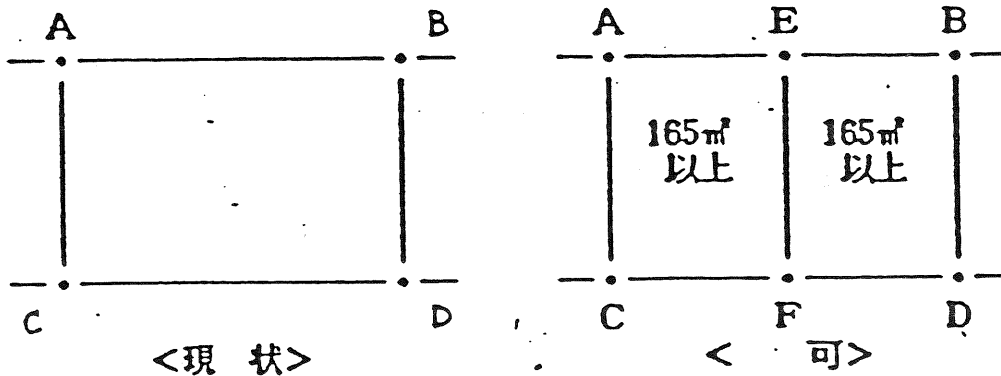
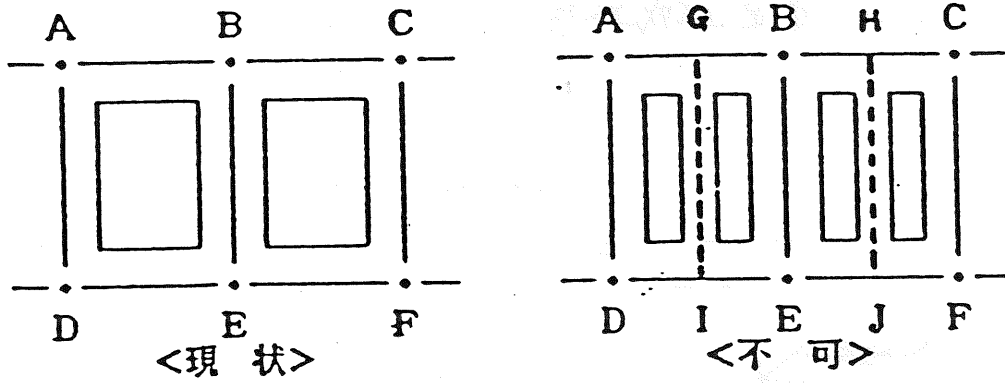

ただし、協定区画番号11-4~5、12-1~8、13-1~2、13-6~9、13-13、14-1及び本協定第13条に定める協定運営委員会の許可を受けたもの。

別図3 第8条(4)

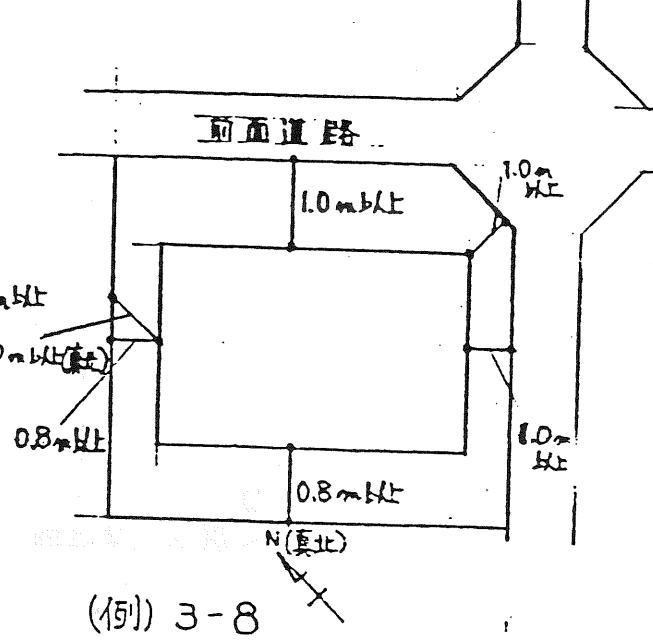
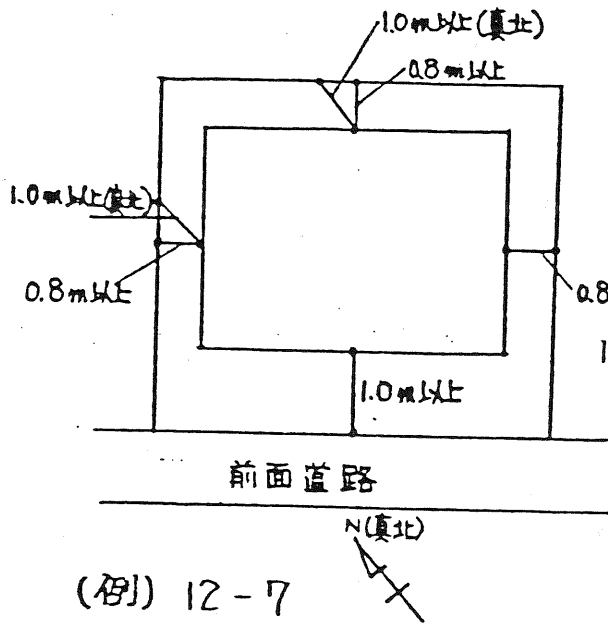

ただし協定区域番号 5-1~18, 6-1~18, 7-1~10, 9-1~20
10-1~10, 14-2~17, 15-11~20 の場合

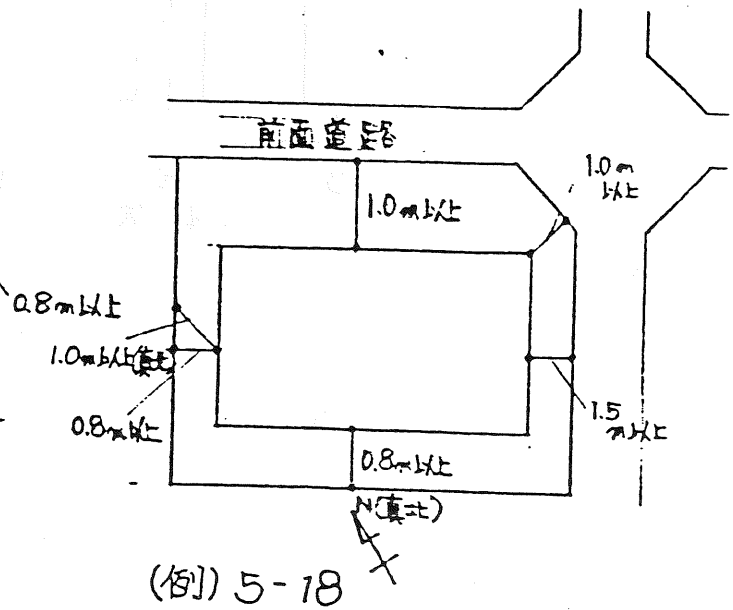
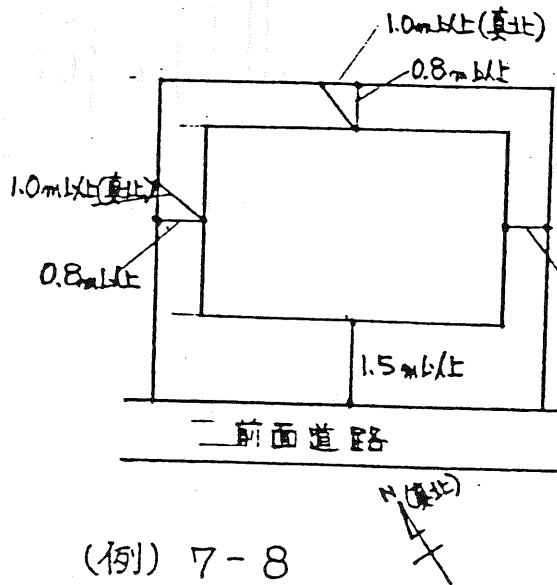

別図 4'

図の場合 $A+B+C+D \leq 3m$

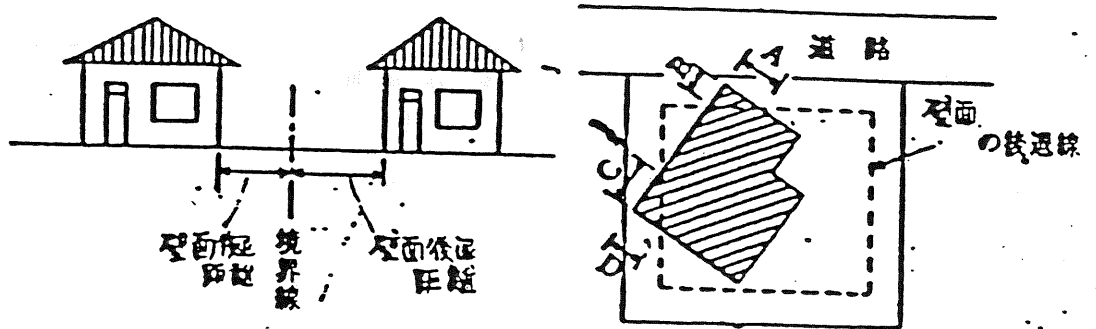

別図 5

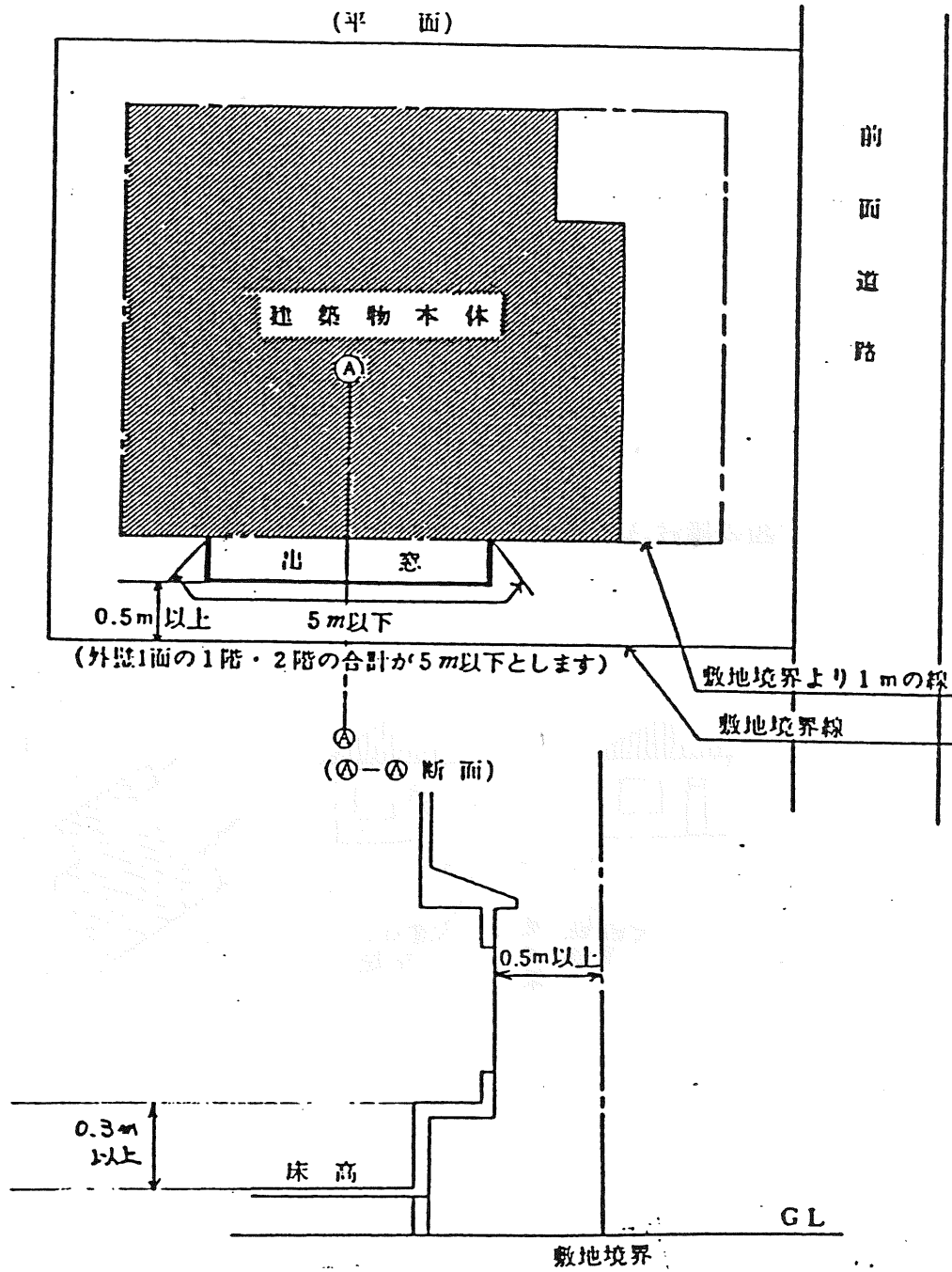

別圖 6

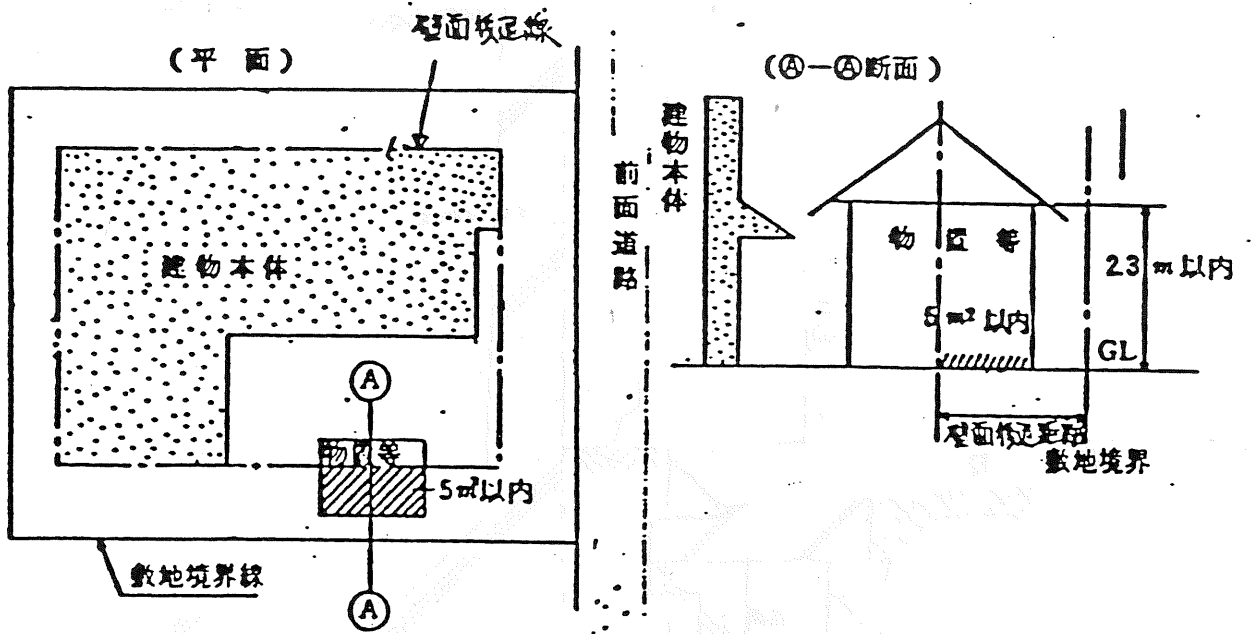

別圖 7

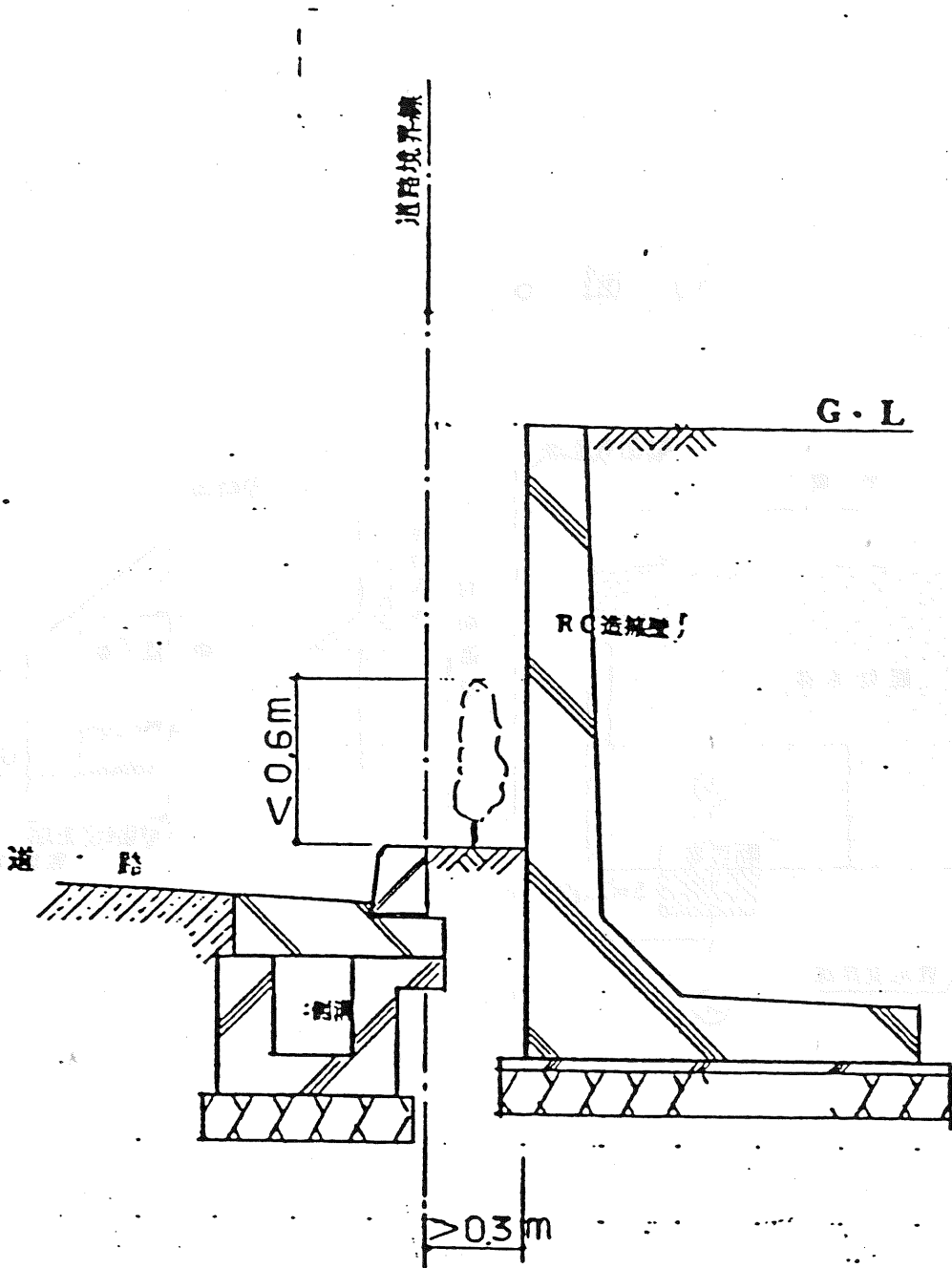

別 図 8

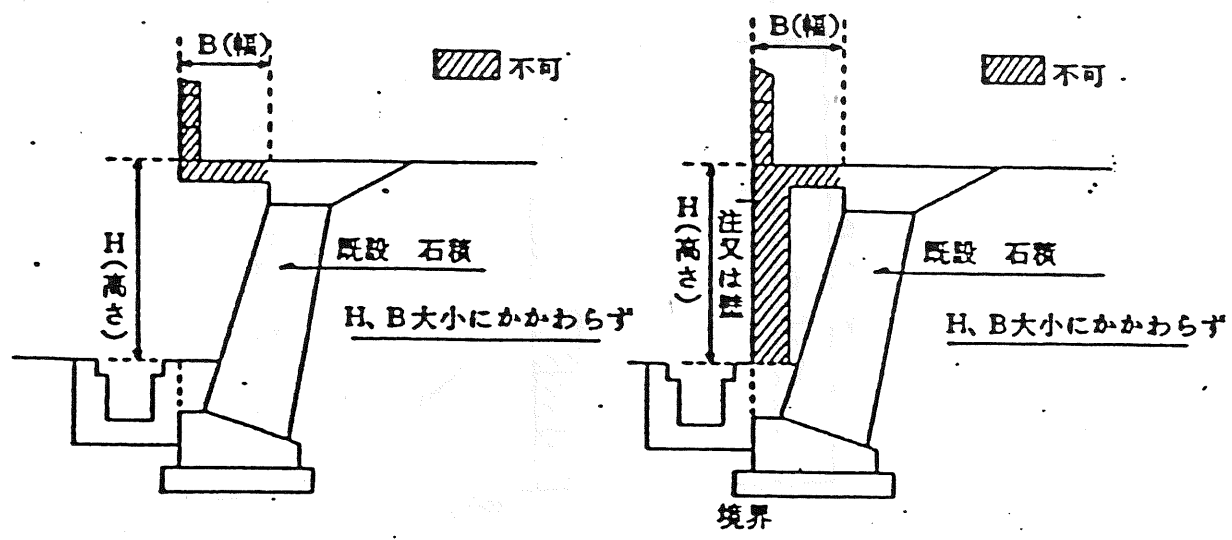

別圖 9

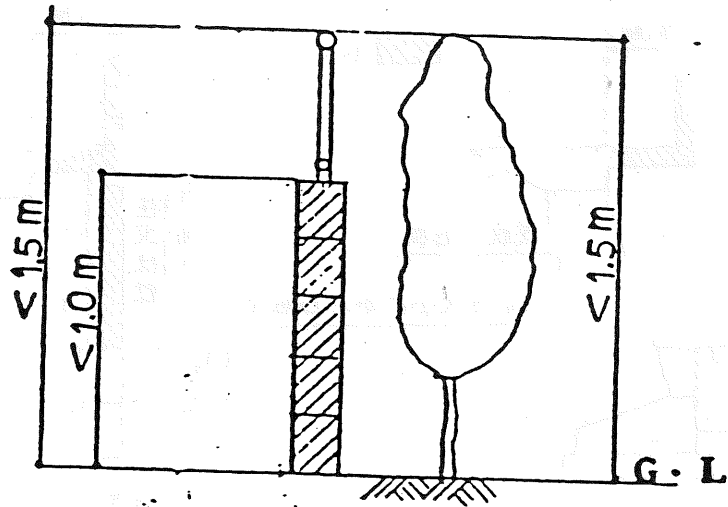

別圖 10

